

An aerial, grayscale photograph of Paris, France, showing a dense urban landscape with numerous buildings and a prominent view of the Eiffel Tower on the right side. The image is used as a background for the document cover.

LA CORNUÉ

PRICES & SPECIFICATIONS

January 2026

CornuFé Series

In 2005, the CornuFé Series was born, introducing La Cornue to a whole new generation. For those who hate to wait, units are inventoried stateside, and are available in eleven colors with three accent options. Designed with the American kitchen in mind, the CornuFé Series features electric multi-function convection ovens and either robust brass burners or induction.

CORNUFÉ 110: c1

1092 W x 650 D x 910 (937 max) H (mm)
 43 W x 25.6 D x 35.8 (36.9 max) H (inches)
 350 lb. uncrated, 465 lb. crated
 High-performance 5 burner gas cooktop
 Double electric convection ovens
 Classic Color Retail: \$14,205
 Suzanne Kasler Color Collection Retail: \$14,975
 Étoilé Color Retail: \$14,975
 Limited Edition: \$16,335

SPECIFICATIONS:

Gas Burners:

1 17,500 BTU Central Burner
 3 12,000 BTU Burners
 1 6,000 BTU Simmer Burner
 Solid Brass Burners Enamel-Capped with Thermocouple Safety Mechanism

Ovens:

French side-swing enameled steel doors
 2 Electric Convection Ovens, one of which features 7 cooking modes
 4 Interior Oven Racks Included (2 flat racks, 2 dropped racks)
 2 Enamel Baking Trays and 1 Trivet
 Left Oven: 430 W x 370 D x 380 H (mm)
 16.9 W x 14.6 D x 15 H (inches)
 2.2 cubic feet
 Right Oven: 430 W x 370 D x 410 H (mm)
 16.9 W x 14.6 D x 16.2 H (inches)
 2.39 cubic feet

Range Accessories: Plaque Adaptor Kit, Wok Ring,
 Grill/Griddle Plate, Brass Burners

Power and Fuel:

Voltage: 240v; 60Hz, 30 AMP Breaker
 Gas connection: 1/2 inch NPT at rear right-hand side
 Natural gas range with propane conversion kit included
 High-Altitude Kit required for elevations above 5,000 feet
 Natural Gas High-Altitude Kit "A037977": Retail for \$65
 Propane High-Altitude Kit "A037982": Retail for \$65

Available Finishes:

Classic Colors: Matte Black, Stainless Steel, Gloss Black,
 Provence Blue, and Pure White
 Étoilé Colors: Morning Dew, Graphite, Ocean, and Wintersky
 Suzanne Kasler
 Colors: Tapestry and Roquefort
 Custom Colors
 & Trims: Consult your La Cornue Sales Rep for more information.

Three Trim Options: Stainless Steel Trim and Rail with
 Satin Chrome Accents
 Stainless Steel Trim with Polished Brass Rail
 and Accents
 Stainless Steel Trim, Polished Stainless Steel Rail, with
 Polished Chrome Accents

NOTE: Side panels are stainless steel for all colors except Gloss Black, Matte Black ranges
 have flat black side panels. The Polished Brass Trim is natural, non coated metal and will
 patina over time.

For coordinating hoods, please see Page 24.

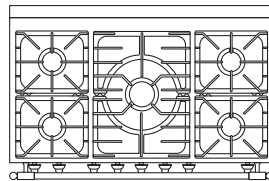
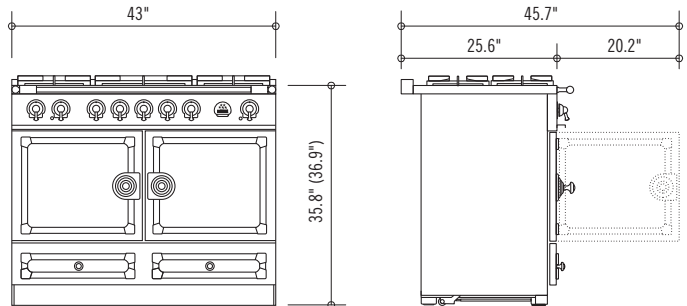

Limited Edition / Designer Series:

Martyn Lawrence Bullard
 Brands Hatch Green
 Goodwood Blue

Matthew Quinn
 Quintessential Teal (Gloss)
 Quintessential Orange

Available in two trims ONLY:

Stainless & Brushed Brass
 Stainless & Polished Brass

CORNUFÉ 110 INDUCTION: C1-I

1092 W x 720 D x 915 (942 max) H (mm)
 43 W x 28.6 D x 36.3 (36.9 max) H (inches)
 350 lb. uncrated 465 lb. crated
 High-performance 5 zone induction cooktop
 Double electric convection ovens
 Classic Color Retail: \$15,915
 Suzanne Kasler Color Collection Retail: \$16,775
 Étoilé Color Retail: \$16,775
 Limited Edition: \$18,305

SPECIFICATIONS:

Induction Cooktop ratings:

Front Left: 1.4 kW (Max) 2.2 kW (Boost)

Rear Left: 1.85 kW (Max) 3.0 kW (Boost)

Center: 2.3 kW (Max) 3.7 kW (Boost)

Front Right: 1.85 kW (Max) 3.0 kW (Boost)

Rear Right: 1.85 kW (Max) 3.0 kW (Boost)

Ovens:

French side-swing enameled steel doors

2 Electric Convection Ovens, one of which features 7 cooking modes

4 Interior Oven Racks Included (2 flat racks, 2 dropped racks)

2 Enamel Baking Trays and 1 Trivet

Left Oven: 430 W x 370 D x 380 H (mm)
 16.9 W x 14.6 D x 15 H (inches)
 2.2 cubic feet

Right Oven: 430 W x 370 D x 410 H (mm)
 16.9 W x 14.6 D x 16.2 H (inches)
 2.39 cubic feet

Power and Fuel:

Voltage: 240v; 60Hz, 50 AMP Breaker

Available Finishes:

Classic Colors: Matte Black, Stainless Steel, Gloss Black,
 Provence Blue, and Pure White

Étoilé Colors: Morning Dew, Graphite, Ocean, and Wintersky

Suzanne Kasler

Colors: Tapestry and Roquefort

Custom Colors

& Trims: Consult your La Cornue Sales Rep for more information.

Three Trim Options: Stainless Steel Trim and Rail with
 Satin Chrome Accents

Stainless Steel Trim with Polished Brass Rail
 and Accents

Stainless Steel Trim, Polished Stainless Steel Rail, with
 Polished Chrome Accents

NOTE: Side panels are stainless steel for all colors except Gloss Black, Matte Black ranges have flat black side panels. The Polished Brass Trim is natural, non-coated metal and will patina over time.

For coordinating hoods, please see Page 24.

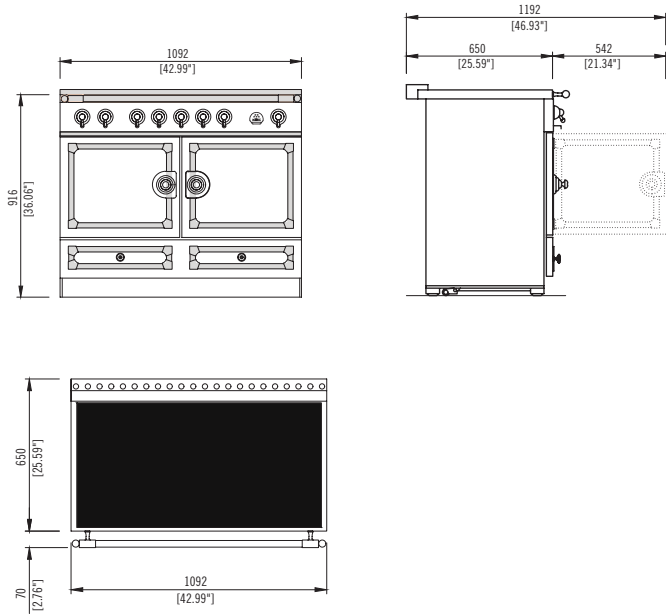

Limited Edition / Designer Series*:

Martyn Lawrence Bullard
 Brands Hatch Green
 Goodwood Blue

Matthew Quinn
 Quintessential Teal (Gloss)
 Quintessential Orange

*Available in two trims ONLY:

Stainless & Brushed Brass
 Stainless & Polished Brass

CORNUFÉ 90 "ALBERTINE": cs

900 W x 650 D x 910 (937 max) H (mm)
35.4 W x 25.6 D x 35.8 (36.9 max) H (inches)
315 lb. uncrated, 410 lb. crated
High-performance 5 burner gas cooktop
Large electric convection oven
Classic Color Retail: \$11,525
Suzanne Kasler Color Collection Retail:\$12,295
Étoilé Color Retail: \$12,295
Limited Edition: \$13,265

SPECIFICATIONS:

Gas Burners:

1 17,500 BTU Central Burner
3 12,000 BTU Burners
1 6,000 BTU Simmer Burner
Solid Brass Enamel-Capped Burners with Thermocouple
Safety Mechanism

Oven:

Enameled steel door with glass inner door
Electric convection oven featuring 7 cooking modes
2 Convection Fans, 8 Heating Elements
714 W x 389 D x 381 H (mm)
28.1 W x 15.3 D x 15 H (inches)
3.81 cubic feet
Range Accessories: Plaque Adaptor Kit, Wok Ring,
Grill/Griddle Plate, Brass Burners

Power and Fuel:

Voltage: 240v; 60Hz, 16 AMP Breaker
Gas connection: 1/2 inch NPT at rear left-hand side
Natural gas range with propane conversion kit included
High-Altitude Kit required for elevations above 5,000 feet
Natural Gas High-Altitude Kit "A037977": Retail for \$65
Propane High-Altitude Kit "A037982": Retail for \$65

Available Finishes:

Classic Colors: Matte Black, Stainless Steel, Gloss Black,
Provence Blue, and Pure White
Étoilé Colors: Morning Dew, Graphite, Ocean, and Wintersky
Suzanne Kasler
Colors: Tapestry and Roquefort
Custom Colors
& Trims: Consult your La Cornue Sales Rep for more information.
Three Trim Options: Stainless Steel Trim and Rail with
Satin Chrome Accents
Stainless Steel Trim with Polished Brass Rail
and Accents
Stainless Steel Trim, Polished Stainless Steel Rail, with
Polished Chrome Accents

NOTE: Side panels are stainless steel for all colors except Gloss Black, Matte Black ranges
have flat black side panels. The Polished Brass Trim is natural, non-coated metal and will
patina over time.

For coordinating hoods, please see Page 24.

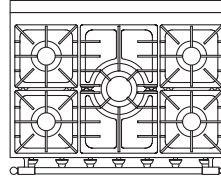
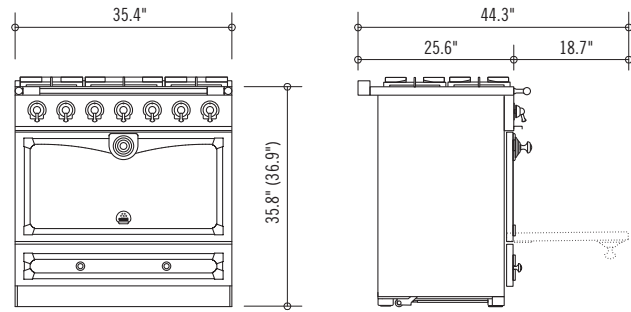

Limited Edition / Designer Series*:

Martyn Lawrence Bullard
Brands Hatch Green
Goodwood Blue

Matthew Quinn
Quintessential Teal (Gloss)
Quintessential Orange

*Available in two trims ONLY:

Stainless & Brushed Brass
Stainless & Polished Brass

CORNUFÉ 90 “ALBERTINE” INDUCTION: c9-1

900 W x 651 (w/o Handles), 729 (w/ Handles) D x 915 (942 max) H (mm)
 35.4 W x 25.62 (w/o Handles), 28.70 (w/ Handles) D x 36.02 (37.08 max) H (inches)
 315 lb uncrated, 410 lb Crated
 High-performance 5 zone induction cooktop
 Large electric convection oven
 Classic Color Retail: \$12,925
 Suzanne Kasler Color Collection Retail: \$13,775
 Étoilé Color Retail: \$13,775
 Limited Edition: \$14,855

SPECIFICATIONS:

Induction Cooktop ratings:

Front Left: 1.4 kW (Max) 2.2 kW (Boost)

Rear Left: 1.85 kW (Max) 3.0 kW (Boost)

Center: 2.3 kW (Max) 3.7 kW (Boost)

Front Right: 1.85 kW (Max) 3.0 kW (Boost)

Rear Right: 1.85 kW (Max) 3.0 kW (Boost)

Note: Front Right and Rear Right Burners can be bridged

Oven:

Enameled steel door with glass inner door

Electric convection oven featuring 7 cooking modes

2 Convection Fans, 8 Heating Elements

1 Deluxe oven tray

1 Large Tray Equipped with Broil Pan

1 Pastry Tray

2 Telescopic Racks

714 W x 389 D x 381 H (mm)

28.1 W x 15.3 D x 15 H (inches)

3.81 cubic feet

Power and Fuel:

Voltage: 240v; 60Hz, 50 AMP Breaker

Available Finishes:

Classic Colors: Matte Black, Stainless Steel, Gloss Black, Provence Blue, and Pure White

Étoilé Colors: Morning Dew, Graphite, Ocean, and Wintersky

Suzanne Kasler

Colors: Tapestry and Roquefort

Custom Colors: Bespoke

Three Trim Options: Stainless Steel Trim and Rail with Satin Chrome Accents

Stainless Steel Trim with Polished Brass Rail and Accents

Stainless Steel Trim, Polished Stainless Steel Rail, with Polished Chrome Accents

NOTE: Side panels are stainless steel for all colors except Gloss Black, Matte Black ranges have flat black side panels. The Polished Brass Trim is natural, non-coated metal and will patina over time.

For coordinating hoods, please see Page 24.

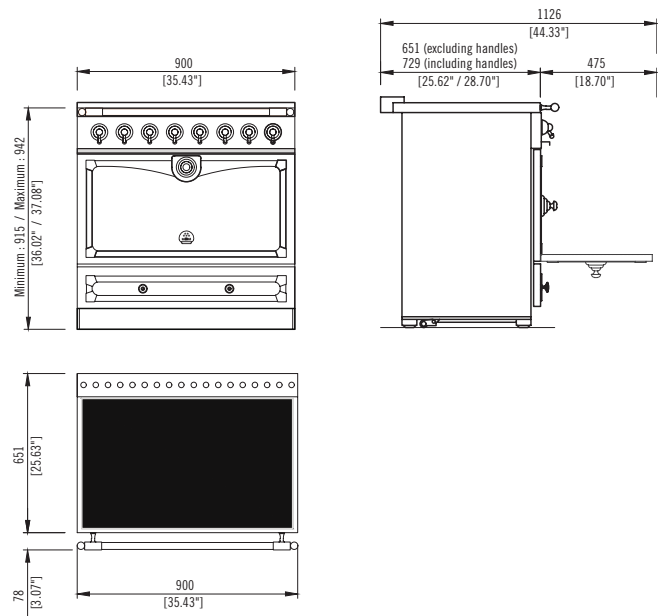

Limited Edition / Designer Series*:

Martyn Lawrence Bullard
 Brands Hatch Green
 Goodwood Blue

Matthew Quinn
 Quintessential Teal (Gloss)
 Quintessential Orange

*Available in two trims ONLY:

Stainless & Brushed Brass
 Stainless & Polished Brass

CORNUFÉ 90 HOOD: H9 (Note: Limited Edition Colors Not Available.)

900 W x 650 D x 700 H (mm)
 35.4 W x 25.6 D x 27.5 H (inches)
 Traditional wall-mounted chimney hood
 Available in all color and trim options
 4-Speed Variable Motor
 One 600 CFM blower – unobstructed air flow with Ø6" duct
 Remote Control and In-Hood Activation Controls
 Three 20W high-intensity lights
 2 dishwasher-safe baffle filters with grease capture system
 Voltage: 120v; 60Hz, total rating: 425W, 3.6 AMP
 Telescopic flue cover extends to maximum hood height of 39.37" (1000 mm)

Classic Color Retail: \$6,505
 Suzanne Kasler Color Collection Retail: \$7,035
 Étoilé Color Retail: \$7,035

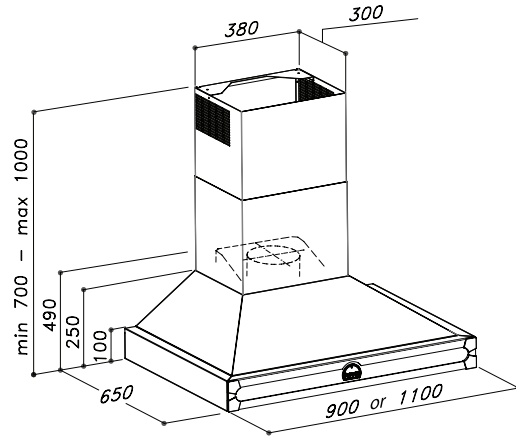

CORNUFÉ 110 HOOD: H1 (Note: Limited Edition Colors Not Available.)

1100 W x 650 D x 700 H (mm)
 43.3 W x 25.6 D x 27.5 H (inches)
 Traditional wall-mounted chimney hood
 Available in all color and trim options
 4-Speed Variable Motor
 One 600 CFM blower – unobstructed air flow with Ø6" duct
 Remote Control and In-Hood Activation Controls
 Three 20W high-intensity Halogen lights
 2 dishwasher-safe baffle filters with grease capture system
 Voltage: 120v; 60Hz, total rating: 425W, 3.6 AMP
 Telescopic flue cover extends to maximum hood height of 39.37" (1000 mm)

Classic Color Retail: \$6,665
 Suzanne Kasler Color Collection Retail: \$7,145
 Étoilé Color Retail: \$7,145

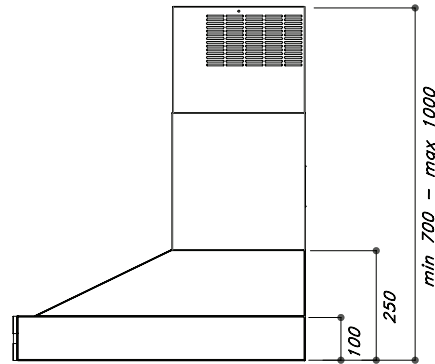

CORNUFÉ HOOD INSERTS

In 2020, La Cornue introduced hood inserts that are available for both ranges in the CornuFé Series. All CornuFé inserts include an internal blower, baffle filters, LED lights, remote control, and 3 speed touch buttons for fan and light control. Please note: The CornuFé inserts are designed for use in custom hoods and are NOT compatible with CornuFé hoods. The CornuFé inserts are inventoried and available for immediate sale.

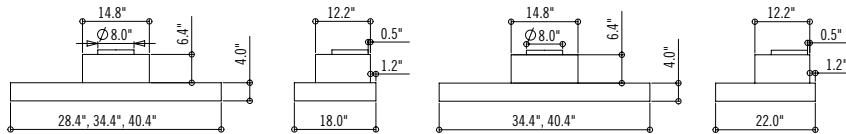

CornuFé Hood Insert: 110LC118

Compatible with C1
 40 3/8" w x 18" d Grade 304 Stainless Steel Hood Insert
 Lights: 2 LED
 Filters: Baffle
 Internal Blower: 600 CFM
 Duct Size: 8"
 Remote Control: Yes
 Approx Weight: 43 lbs
 Retail: \$1,250

CornuFé Hood Insert: 110LC122

Compatible with C1
 40 3/8" w x 22" d Grade 304 Stainless Steel Hood Insert
 Lights: 2 LED
 Filters: Baffle
 Internal Blower: 600 CFM
 Duct Size: 8"
 Remote Control: Yes
 Approx Weight: 49 lbs
 Retail: \$1,500

CornuFé Hood Insert: 90LC118

Compatible with C9
 34 3/8" w x 18" d Grade 304 Stainless Steel Hood Insert
 Lights: 2 LED
 Filters: Baffle
 Internal Blower: 600 CFM
 Duct Size: 8"
 Remote Control: Yes
 Approx Weight: 40 lbs
 Retail: \$1,200

CornuFé Hood Insert: 90LC122

Compatible with C9
 34 3/8" w x 22" d Grade 304 Stainless Steel Hood Insert
 Lights: 2 LED
 Filters: Baffle
 Internal Blower: 600 CFM
 Duct Size: 8"
 Remote Control: Yes
 Approx Weight: 46 lbs
 Retail: \$1,450

CORNUFÉ CASCADE : CH3630CAC & CH4430CAC

Hood Style: Concave
 Available in both 36" & 44"
 36"W x 24"D x 30"H (390 or 600 cfm/8" collar)
 44"W x 24"D x 30"H (390 or 600 cfm/8" collar and 1200 cfm/10")

Duct Cover Options:
 12", 24" and 48" Tall
Custom Duct Cover heights are available

Product Weight:
 36"(30"H) : 97 lbs
 44"(30"H) : 124 lbs

Electrical Requirements:
 600 CFM models draw approx. 2.7 Amps
 1200 CFM models draw approx. 5.4 Amps
 Voltage: 120v; 60Hz; 15amps

Hood Sone Level:
 Ranges from 5-7

CORNUFÉ CASCADE 36"
 Classic Color Retail: Starting from \$7,739
 Suzanne Kasler Color Collection Retail: Starting from \$8,149
 Étoilé Color Retail: Starting from \$8,149
Trims available: Satin Chrome, Polished Chrome, Polished Brass

CORNUFÉ CASCADE 44"
 Classic Color Retail: Starting from \$8,149
 Suzanne Kasler Color Collection Retail: Starting from \$8,589
 Étoilé Color Retail: Starting from \$8,589
Trims available: Satin Chrome, Polished Chrome, Polished Brass

Available in Limited Edition Colors and Trims - pricing varies - refer to price sheet

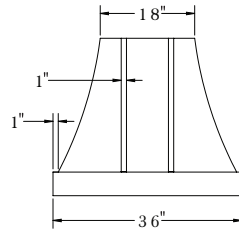

FRONT VIEW

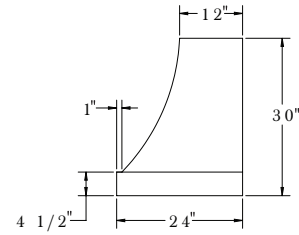

SIDE VIEW

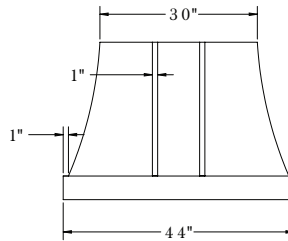

FRONT VIEW

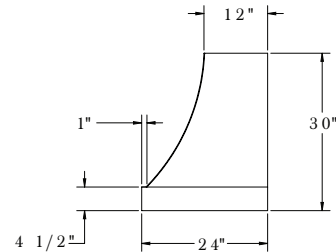

SIDE VIEW

CORNUFÉ EUCLID : CH3630EUC & CH4430EUC

Hood Style: Trapezoid

Available in both 36" & 44"
 36"W x 24"D x 30"H (600 cfm/8" collar)
 44"W x 24"D x 30"H (1200 cfm/10" collar)

Duct Cover Options:
 12", 24" and 48" Tall
Custom Duct Cover heights are available

Product Weight: 36"(30"H) : 98 lbs/ 44"(30"H) : 126 lbs

Electrical Requirements:
 600 CFM models draw approx. 2.7 Amps
 1200 CFM models draw approx. 5.4 Amps
 Voltage: 120v; 60Hz; 15amps

Hood Sone Level:
 Ranges from 5-7

CORNUFÉ EUCLID 36"
 Classic Color Retail: Starting from \$7,469
 Suzanne Kasler Color Collection Retail: Starting from \$7,869
 Étoilé Color Retail: Starting from \$7,869
Trims available: Satin Chrome, Polished Chrome, Polished Brass

CORNUFÉ EUCLID 44"
 Classic Color Retail: Starting from \$7,699
 Suzanne Kasler Color Collection Retail: Starting from \$8,119
 Étoilé Color Retail: Starting from \$8,119
Trims available: Satin Chrome, Polished Chrome, Polished Brass

Available in Limited Edition Colors and Trims - pricing varies - refer to price sheet

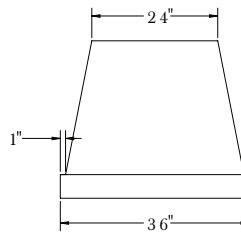

FRONT VIEW

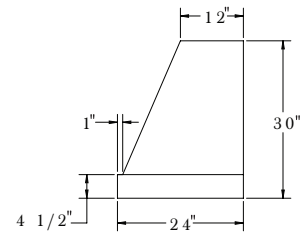

SIDE VIEW

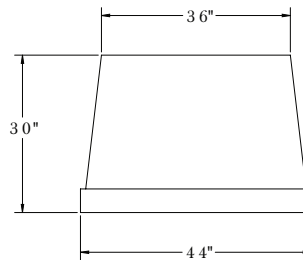

FRONT VIEW

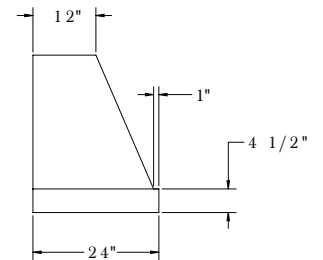

SIDE VIEW

CORNUFÉ LOGE : CH3630LGE & CH4430LGE

Hood Style: Box

Available in both 36" & 44"

36"W x 24"D x 30"H, 42"H or 54"H (600 cfm/8" collar)

44"W x 24"D x 30"H, 42"H or 54"H (1200 cfm/10" collar)

Product Weight:

36"(30"H) : 104 lbs / 36"(42"H) : 122 lbs / 36"(54"H) : 141 lbs

44"(30"H) : 130 lbs / 44"(42"H) : 151 lbs / 44"(54"H) : 172 lbs

Electrical Requirements:

600 CFM models draw approx. 2.7 Amps

1200 CFM models draw approx. 5.4 Amps

Voltage: 120v; 60Hz; 15amps

Hood Sone Level:

Ranges from 5-7

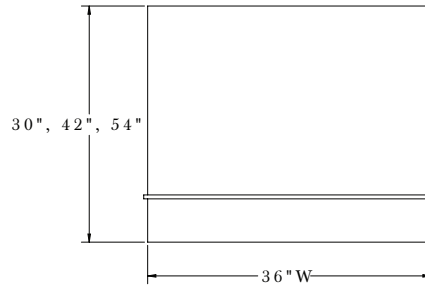

FRONT VIEW

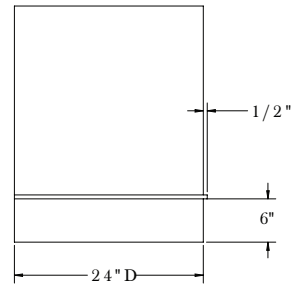

SIDE VIEW

CORNUFÉ LOGE 36"

Classic Color Retail: Starting from \$7,119

Suzanne Kasler Color Collection Retail: Starting from \$7,499

Étoilé Color Retail: Starting from \$7,499

Trims available: *Satin Chrome, Polished Chrome, Polished Brass*

CORNUFÉ LOGE 44"

Classic Color Retail: Starting from \$7,319

Suzanne Kasler Color Collection Retail: Starting from \$7,719

Étoilé Color Retail: Starting from \$7,719

Trims available: *Satin Chrome, Polished Chrome, Polished Brass*

Available in Limited Edition Colors and Trims - pricing varies - refer to price sheet

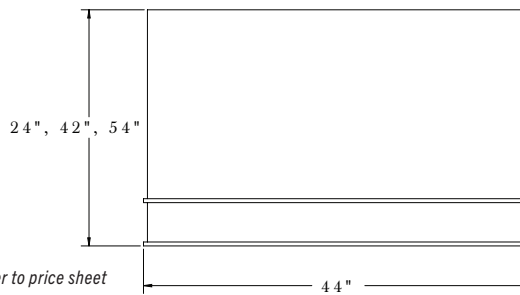

FRONT VIEW

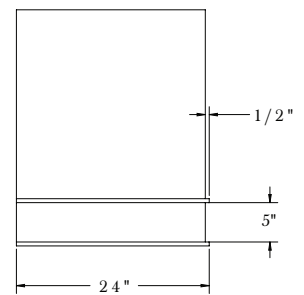

SIDE VIEW

CORNUFÉ MARQUEE : CH3630MRQ & CH4430MRQ

Hood Style: Arched Front

Available in both 36" & 44"

36"W x 24"D x 30"H (600 cfm/8" collar)

44"W x 24"D x 30"H (1200 cfm/10" collar)

Duct Cover Options:

12", 24" and 48" Tall

Custom Duct Cover heights are available

Product Weight: 36"(30"H) : 101 lbs / 44"(30"H) : 126 lbs

Electrical Requirements:

600 CFM models draw approx. 2.7 Amps

1200 CFM models draw approx. 5.4 Amps

Voltage: 120v; 60Hz; 15amps

Hood Sone Level:

Ranges from 5-7

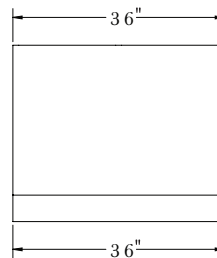

FRONT VIEW

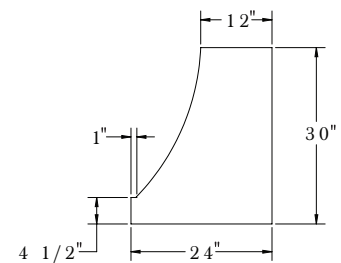

SIDE VIEW

CORNUFÉ MARQUEE 36"

Classic Color Retail: Starting from \$7,399

Suzanne Kasler Color Collection Retail: Starting from \$7,799

Étoilé Color Retail: Starting from \$7,799

Trims available: *Satin Chrome, Polished Chrome, Polished Brass*

CORNUFÉ MARQUEE 44"

Classic Color Retail: Starting from \$7,609

Suzanne Kasler Color Collection Retail: Starting from \$8,019

Étoilé Color Retail: Starting from \$8,019

Trims available: *Satin Chrome, Polished Chrome, Polished Brass*

Available in Limited Edition Colors and Trims - pricing varies - refer to price sheet

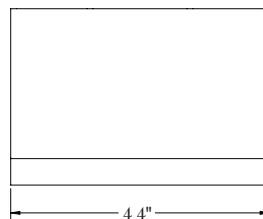

FRONT VIEW

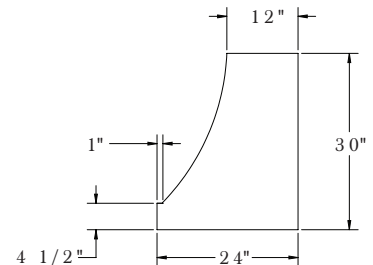

SIDE VIEW

CornuFé Series Details & Accessories

CLASSIC COLORS

N	Matte Black
M	Gloss Black
I	Stainless Steel
W	Pure White
L	Provence Blue

ÉTOILÉ COLORS

P	Morning Dew
G	Graphite
O	Ocean
H	Wintersky

SUZANNE KASLER COLOR COLLECTION

A	Tapestry
Q	Roquefort

LIMITED EDITION COLORS / DESIGNER SERIES MARTYN LAWRENCE BULLARD

MQT	Quintessential Teal (Gloss)
MQO	Quintessential Orange
MLG	Brands Hatch Green
MLB	Goodwood Blue

Limited Edition Trim Options

B	Stainless Steel Polished Brass Polished Brass
L	Stainless Steel Brushed Brass Brushed Brass

TRIM OPTIONS

	Trim	Accents	Rails
N	Stainless Steel	Satin Chrome	Stainless Steel
F	Stainless Steel	Polished Brass	Polished Brass
P	Stainless Steel	Polished Chrome	Polished Stainless Steel

Note: The Polished Brass Trim is natural, non coated metal and will patina over time.

ACCESSORIES (AVAILABLE FOR 110 AND 90):

Model Number	Description	Price
CFEBPLATE	French Plaque for CornuFé 110 Dual Fuel Ranges	\$1,655
CFEBPLATE90	French Plaque for CornuFé 90 Dual Fuel Ranges	\$1,655
CFEGRIDDLE	Grill/Griddle Plate for all CornuFé Dual Fuel Ranges	\$825
P050553	Wok Adapter for all CornuFé Dual Fuel Ranges	\$245
A037977	High Altitude Kit - Natural Gas for all CornuFé Dual Fuel Ranges	\$65
A037982	High Altitude Kit - Propane for all CornuFé Dual Fuel Ranges	\$65
09KIRSIR01	Recirculating kit for CornuFé Hood	\$485
P030292	CornuFé 110 Extra Flat Rack	\$105
CFDF5BB	CornuFé Dual Fuel 5 Brass Burner Accessory Kit	\$775

Please confirm inventory status at time of order.

The Flamberge Rôtisserie

The Flamberge Rôtisserie is a wall-mounted gas rôtisserie designed for residential use. Constructed with a concave rear wall of solid cast iron, it is heated by a powerful gas burner set beneath three motorized spits. Synthetic wicks pull the heat up through the vaulted back of the unit, allowing the radiant heat to gently cook foods as they rotate slowly on a spit over the flame.

FLAMBERGE RÔTISSERIE: BFG

Unit Dimensions: 755 W x 380 D x 725 H (mm)
29.7 W x 15 D x 28.5 H (inches)

Minimum Cutout Dimensions: 760 W x 457 D x 730 H (mm)
30 W x 18 D x 28.7 H (inches)

Dimensions of Metal Trim Frame: 815 W x 792 H (mm)
32 W x 31.2 H (inches)

Crated Weight: 330 lbs; Uncrated Weight: 132 lbs

Voltage: 120v, 10 AMP Breaker

Available in gas only (Natural or Propane)

Gas – 27,000 BTU Natural or 25,000 BTU Propane

Accessories Included:

2 Metal Spits

1 Fish Basket

1 Porcelain Enamel Drip Tray

Starting from \$19,100

Please note: The Centenary Rôtisserie is a UL-Approved product for residential installation. This is a zero clearance product. Ventilation is not required, but may be used as desired.

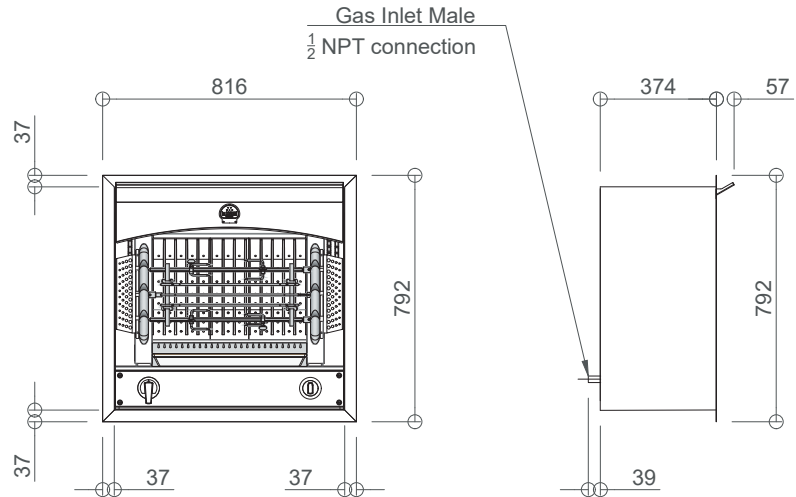

Ordering & Shipping

All Château products (Château Ranges, Cooktops, Hoods, Rôtisserie, Cabinetry and Accessories) are custom-ordered and quoted on a per-job basis. In our current environment, lead times are constantly changing, please consult your sales person for current lead time. Freight rates are not reflected in retail prices and will be quoted on a per-job basis. Standard freight is air freighted from France to U.S. and then truck to local delivery.

All CornuFé products (CornuFé 110 and 90) are inventoried at Middleby Residential and shipped upon order or around target delivery date. If a product is not in stock, lead time will be quoted. Standard delivery time is 1-3 weeks for products in stock. Freight rates are not reflected in retail prices and will be quoted at time of sale.

CHÂTEAU SERIES SHIPPING & DELIVERY

All Château units must ship via inside delivery due to weight and value. Quoted freight includes wooden crate and import costs (customs, duties and taxes).

Inside Delivery Includes:

- Insurance
- Delivery crew of 2-4 men
- Delivery up to 2 flights of stairs (includes outside and inside stairs)
- * *Passageway must be accessible and wide enough for delivery crew to maneuver*
- 90 minute onsite delivery time
- Placement of unit inside customer's home, three feet away from its location
- Debris removal of original crate packaging, including the wooden crate, pallet, Styrofoam, and plastic
- Delivery Monday to Friday from 8am-5pm
- Delivery within designated 5-hour delivery window, during normal business hours

CORNUFÉ SERIES SHIPPING & DELIVERY

CornuFé units may be shipped curbside/warehouse delivery or in-home delivery. Note that rates for each option are quoted by state and unit.

Curbside delivery service includes:

- Insurance
- Delivery crew of 1-2 men
- Delivery up to the driveway
- Delivery Monday to Friday from 8am-5pm
- Delivery within designated 5-hour delivery window, during normal business hours

In-home delivery is identical to Château in-home as detailed above

Items *not* covered (note the below conditions will incur additional costs):

- Delivery time of over 90 minutes
- Additional labor (more than 2 men for curbside delivery and more than 3 men for inside delivery)
- Waiting time (if recipient not home or not ready to receive order upon arrival)
- Customer pick-up
- Consignee no show
- Consignee refusal of delivery
- Consignee refusal within 24 hours of scheduled delivery
- Required use of elevator for delivery
- Unusual transportation costs – ferries, cranes, etc.
- Weekend or holiday delivery
- After hours delivery
- Specific time delivery
- Storage of unit at local distribution center

Conditions *never* covered under freight charge:

- Gas or electrical hookup
- Removal of any non-La Cornue debris
- Light assembly

Please note: It is the responsibility of the purchaser to arrange installation. La Cornue is not responsible for installation.

NATIONWIDE SERVICE & PARTS INFORMATION

For service, contact the La Cornue Service Center at 877-LACORNU(e) or 877-522-6768.

LA CORNUÉ WARRANTY AND LIMITATIONS

La Cornue warrants the original user that the product(s) manufactured are free from defects on material and workmanship for a period of five years from date of installation, not to exceed 66 months from date of shipment by Company. For extended warranty options due to delay in installation, please contact us at lacornueservice@middlebyresidential.com.

CODE COMPLIANCE INFORMATION

Château Stoves, Cooktops and Rôtisserie are UL Approved for residential use *unless otherwise noted*.

CornuFé Stoves carry CSA Approval for residential installation

Please note: According to ANSI Standard Z223, noncombustible ventilation equipment must be used in conjunction with La Cornue equipment.

LACORNUE

PURVEYORS OF HANDCRAFTED FRENCH RANGES SINCE 1908

A MEMBER OF THE MIDDLEBY RESIDENTIAL LUXURY BRAND PORTFOLIO

LA CORNUE IS DISTRIBUTED IN USA, MEXICO AND WILLIAMS-SONOMA CANADA
BY MIDDLEBY RESIDENTIAL. FOR MORE INFORMATION, OR TO FIND A DEALER NEAR YOU, PLEASE
CONNECT WITH US: [FACEBOOK.COM/LACORNUE](https://www.facebook.com/lacornue) | [INSTAGRAM.COM/LACORNUEUSA](https://www.instagram.com/lacornueusa) | [TWITTER.COM/LACORNUE](https://www.twitter.com/lacornue)

lacornueusa.com

