

An aerial, grayscale photograph of Paris, France, showing a dense urban landscape with numerous buildings and a prominent view of the Eiffel Tower on the right side. The image is used as a background for the document cover.

LA CORNUÉ

PRICES & SPECIFICATIONS

January 2026



PURVEYORS OF HANDCRAFTED FRENCH RANGES SINCE 1908

G4 Château Series 2
Château Suprême by Ferris Rafauli 17
Château Moderne by Matthew Quinn 21
CornuFé Series 22
Rôtisserie 30
Cuisine de Château 32
Corner & Filler Cabinetry 39
Accessories 40
Ordering & Shipping 41

G4 Château Series Ranges & Rangetops

Each Château range and cooktop is made by hand in the La Cornue atelier in France. Each piece is a unique custom creation, built with a specific owner in mind. Ranges are built to a standard height of 914 mm (36"). The legs are adjustable. The height of the range can vary from 912 mm (35.9") to 928 mm (36.5"). Custom heights are available by quote.

BURNER SPECIFICATIONS

Large Front Burners	17,000 BTUs
Small Back Burners	7,500 BTUs
Power Burner	22,000 BTUs
Large & Petite Plaque	7,500 BTUs
Lava-rock Grill	14,500 BTUs
Induction Element (2 burners)	2100 Watts*
Teppanyaki	2000 Watts

*burners can be bridged

OVEN SPECIFICATIONS

Grand Vaulted Gas Oven with Electric Broiler	13,000 BTUs
22.6W x 19.8D x 11.8H	3.1 cubic feet (left)
Grand Vaulted Electric Oven with Electric Broiler	
22.6W x 17.5D x 11.8H	2.7 cubic feet (right)
Standard Vaulted Gas Oven with Electric Broiler	11,000 BTUS
16.8W x 19.8D x 11.8h	2.3 cubic feet (left)
Standard Vaulted Electric Oven with Electric Broiler	
16.8W x 17.5D 11.8H	2.0 cubic feet (right)

CUSTOMIZATION TO BE SPECIFIED AT TIME OF ORDER

Voltage: Standard voltage is 240, single phase.
Fuel: Standard fuel type is Natural Gas; please specify if Propane is desired.

Altitude: Please specify if range will be installed over 2,000 feet.

Custom Height: Please specify if a custom height is desired, up to 38.2 inches. Price to quote.

Extended Cooktop: For a unique continuous cooktop work surface, the Stainless Steel cooktop frame may be extended laterally. Maximum total length varies based on range specified, please inquire. Price to quote.

Flushed Backsplash (additional charge): Ideal for island applications, this may be ordered in 100 mm depth (Total Depth 700 mm). Note that the standard backsplash is raised 2" above the cooktop frame.

\$1,300 for a seamed flush backsplash and \$7,500 for an integrated seamless flush backsplash.

Toe Kick: Stainless Steel Toe Kick is standard. A colored toe kick can be added to match the range. (See page 13 for pricing)

Brass or Copper Toe Kick: Brass or Copper Toe Kicks are available for ranges and cabinets for an upcharge. Price to Quote.

Clear Coated Varnish: Available on Brushed Brass, Polished Brass, Brushed Copper, Polished Copper Trims and Range Finishes.

Custom Color: \$3,400

Leather Handrail: Available in multiple colors.



2 GAS BURNERS

Two brass burners set inside an enameled drip tray and topped with an enamel-coated cast iron grate.

Front Burner: Natural Gas 17,000 BTU / Propane Gas up to 12,500 BTU
 Rear Burner: Natural Gas 7,500 BTU / Propane Gas up to 6,000 BTU

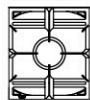

POWER BURNER

One oversized brass burner set inside an enameled drip tray with an enamel-coated cast iron grate. Ideal for oversized sauce pans, searing, sautéing, and high heat cooking.

Natural Gas 22,000 BTU / Propane Gas up to 22,000 BTU

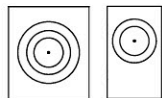

PLAQUE "FRENCH TOP": LARGE, PETITE

One gas burner installed beneath a solid cast iron top, serving as the heat source for the entire cast iron surface. The cast iron plaque becomes the cooking center and offers variable heat zones with the strongest heat in the center, directly above the burner, and diffusing outwards. Allows for multiple sauce pans above a single indirect heat source.

Natural Gas 7,500 BTU / Propane Gas up to 7,500 BTU



LAVA-ROCK GRILL

Linear gas burner running front-to-back set beneath a bed of natural lava rocks and topped with an enamel-coated open-style grill.

Natural Gas 14,500 BTU / Propane Gas up to 14,500 BTU



TEPPANYAKI

Flat, solid, griddle-style cooking surface heated by electricity to create a consistent and solid cooking surface ideal for steak, seafood, shrimp, rice, eggs and vegetables with a minimum temperature of 140°F and a maximum temperature of 482°F.

Teppanyaki element incurs an upcharge of \$3,500



CERAMIC GLASS INDUCTION

Ceramic glass induction hob features 2 identical cooking areas, 220 x 180 mm 2100 watts, 3700 watts max

Induction element incurs an upcharge of \$3,500 per element

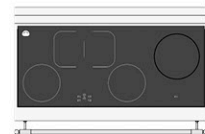

ALL INDUCTION COOKTOP

Available on the 150, 120, 90, and 60 ranges only. The 150 and 120 cooktops feature a five burner cooktop and the 90 and 60 features a 4 burner cooktop. When this cooktop is specified, the ovens will always be electric.

GRAND PALAIS 180: G48

1800 W x 700 D x 914 H (mm)
 70.9 W x 27.6 D x 36 H (inches)
 Approx. 710 lb. uncrated, 1320 lb. crated
 Choice of 7 top configurations
 Starting from \$92,000

STANDARD FEATURES INCLUDE:

- 1 Grand Vaulted Gas Oven with Electric Broiler (left)
- 1 Grand Vaulted Electric Oven with Electric Broiler (right)

Oven specifications can be found on page 2

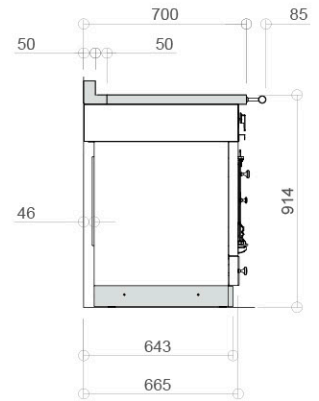
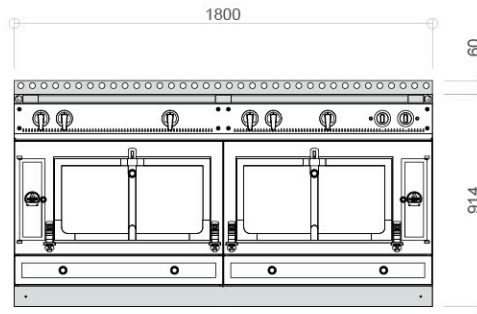

GRAND PALAIS RANGETOP 180: T48

1800 W x 700 D x 200 H (mm)
 70.9 W x 27.6 D x 7.9 H (inches)
 Approx. 290 lb. uncrated, 450 lb. crated
 Choice of 7 top configurations
 Starting from \$39,200

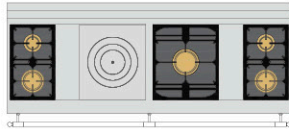
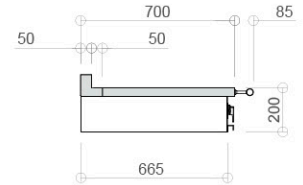
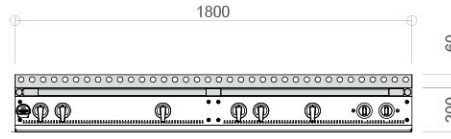

180 US N1

- 2 gas burners (small burner at the back)
- 1 Plaque "French Top" (large)
- 1 maxi power burner
- 2 gas burners (small burner at the back)

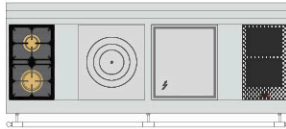

180 US N2*

- 2 gas burners (small burner at the back)
- 1 Plaque "French Top" (large)
- 1 large electric Teppanyaki
- 2 induction plates



180 US N3

- 2 gas burners (small burner at the back)
- 1 Plaque "French Top" (large)
- 1 maxi power burner
- 1 large electric Teppanyaki

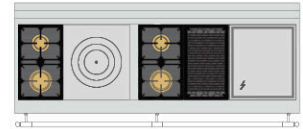

180 US N5

- 2 gas burners (small burner at the back)
- 1 Plaque "French Top" (large)
- 2 gas burners (small burner at the back)
- 1 gas lava-rock grill
- 1 large electric Teppanyaki

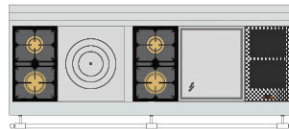

180 US N8*

- 2 gas burners (small burner at the back)
- 1 Plaque "French Top" (large)
- 2 gas burners (small burner at the back)
- 1 large electric Teppanyaki
- 2 induction plates

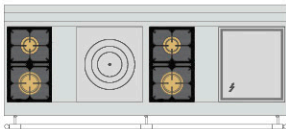

180 US N9

- 2 gas burners (small burner at the back)
- 1 Plaque "French Top" (large)
- 2 gas burners (small burner at the back)
- 1 large electric Teppanyaki

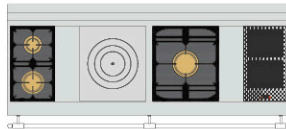

180 US NM*

- 2 gas burners (small burner at the back)
- 1 Plaque "French Top" (large)
- 1 maxi power burner
- 2 induction plates

CHATEAU 165: G46

1650 W x 700 D x 914 H (mm)
 65.0 W x 27.6 D x 36 H (inches)
 Approx. 640 lb. uncrated, 1280 lb. crated
 Choice of 5 top configurations
 Starting from \$86,400

STANDARD FEATURES INCLUDE:

- 1 Grand Vaulted Gas Oven with Electric Broiler (left)
- 1 Vaulted Electric Oven with Electric Broiler (right)

Oven specifications can be found on page 2

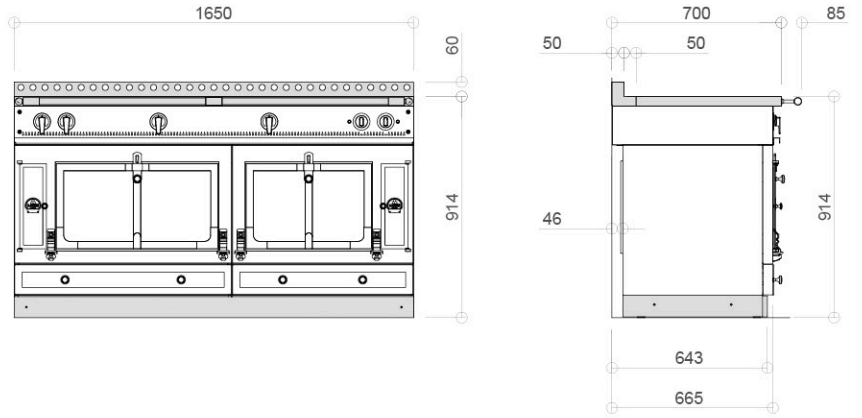

CHATEAU RANGETOP 165: T46

1650 W x 700 D x 200 H (mm)
 65.0 W x 27.6 D x 7.9 H (inches)
 Approx. 290 lb. uncrated, 400 lb. crated
 Choice of 5 top configurations
 Starting from \$37,700

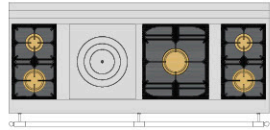
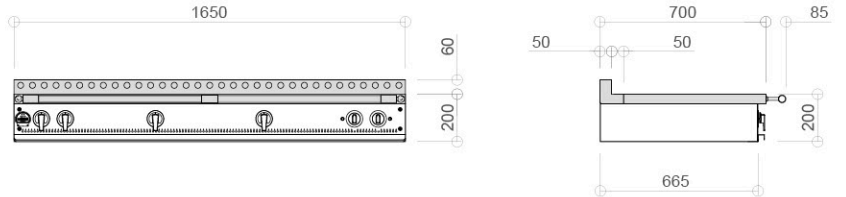

165 US L1

- 2 gas burners (small burner at the back)
- 1 Plaque "French Top" (large)
- 1 maxi power burner
- 2 gas burners (small burner at the back)

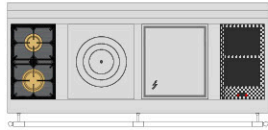

165 US L2*

- 2 gas burners (small burner at the back)
- 1 Plaque "French Top" (large)
- 1 large electric Teppanyaki
- 2 induction plates



165 US L3

- 2 gas burners (small burner at the back)
- 1 Plaque "French Top" (large)
- 1 maxi power burner
- 1 large electric Teppanyaki

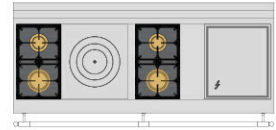

165 US L9

- 2 gas burners (small burner at the back)
- 1 Plaque "French Top" (large)
- 2 gas burners (small burner at the back)
- 1 large electric Teppanyaki

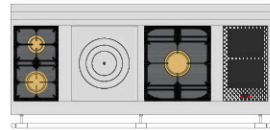

165 US LM*

- 2 gas burners (small burner at the back)
- 1 Plaque "French Top" (large)
- 1 maxi power burner
- 2 induction plates

CHÂTEAU 150: G45

1500 W x 700 D x 914 H (mm)
 59.1 W x 27.6 D x 36 H (inches)
 Approx. 620 lb. uncrated, 1230 lb. crated
 Choice of 9 top configurations
 Traditional Cooktop Configurations starting from \$79,900
 All Induction Cooktop Configuration starting from \$87,800

TRADITIONAL CHÂTEAU COOKTOP CONFIGURATION RANGES INCLUDE:

- 1 Vaulted Gas Oven with Electric Broiler (left)
- 1 Vaulted Electric Oven with Electric Broiler (right)

ALL INDUCTION CHÂTEAU COOKTOP CONFIGURATION RANGE INCLUDES:

- 2 Vaulted Electric Ovens with Electric Broilers

Oven specifications can be found on page 2

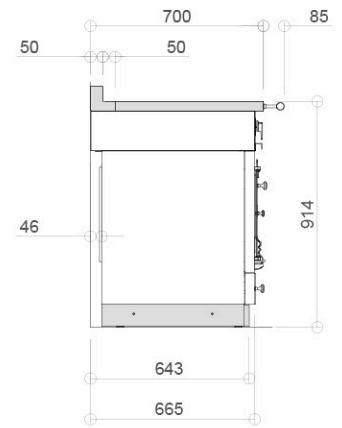
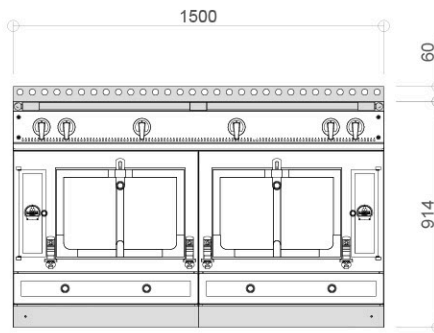

CHATEAU RANGETOP 150: T45

1500 W x 700 D x 200 H (mm)
 59.1 W x 27.6 D x 7.9 H (inches)
 Approx. 220 lb. uncrated, 350 lb. crated
 Choice of 9 top configurations
 Traditional Cooktop Configurations starting From \$28,700
 All Induction Cooktop Configuration starting from \$31,600

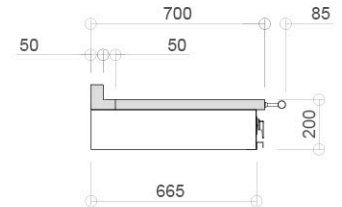
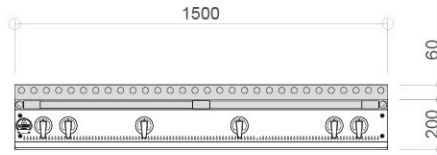

TRADITIONAL COOKTOP CONFIGURATION OPTIONS

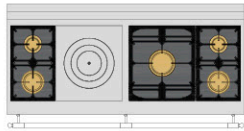

- 150 US K1**
 2 gas burners (small burner at the back)
 1 Plaque "French Top" (large)
 1 maxi power burner
 2 gas burners (small burner at the back)

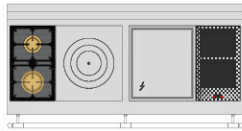

- 150 US K2***
 2 gas burners (small burner at the back)
 1 Plaque "French Top" (large)
 1 large electric Teppanyaki
 2 induction plates



- 150 US K3***
 2 gas burners (small burner at the back)
 1 Plaque "French Top" (large)
 2 gas burners (small burner at the back)
 2 induction plates

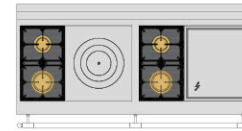

- 150 US K4**
 2 gas burners (small burner at the back)
 1 Plaque "French Top" (large)
 2 gas burners (small burner at the back)
 1 large electric Teppanyaki

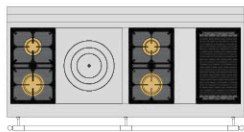

- 150 US K5**
 2 gas burners (small burner at the back)
 1 Plaque "French Top" (large)
 2 gas burners (small burner at the back)
 1 gas lava-rock grill

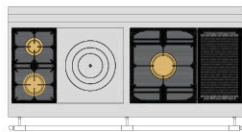

- 150 US K6**
 2 gas burners (small burner at the back)
 1 Plaque "French Top" (large)
 1 maxi power burner
 1 gas lava-rock grill

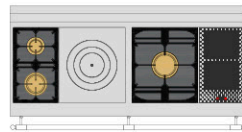

- 150 US KM***
 2 gas burners (small burner at the back)
 1 Plaque "French Top" (large)
 1 maxi power burner
 2 induction plates

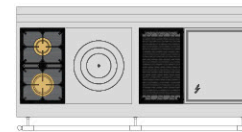

- 150 US KH**
 2 gas burners (small burner at the back)
 1 Plaque "French Top" (large)
 1 gas lava-rock grill
 1 large electric Teppanyaki

ALL INDUCTION COOKTOP CONFIGURATION OPTION



- 150 US KI**
 Full Induction 150 Plate includes:
 2 rectangular burners - both burners can be bridged together
 2 circular burners
 1 large circular burner

CHÂTEAU 120: 642

1200 W x 700 D x 914 H (mm)
 47.2 W x 27.6 D x 36 H (inches)
 Approx. 490 lb. uncrated, 780 lb. crated
 Choice of 8 top configurations
 Traditional 3-Element Cooktop configuration starting from \$69,300
 Traditional 4-Element with induction Cooktop configuration starting from \$74,500
 All Induction Cooktop configuration starting from \$76,300

TRADITIONAL CHÂTEAU COOKTOP CONFIGURATION RANGES INCLUDE:
 1 Vaulted Gas Oven with Electric Broiler (left)
 1 Vaulted Electric Oven with Electric Broiler (right)

ALL INDUCTION CHÂTEAU COOKTOP CONFIGURATION RANGE INCLUDES:
 2 Vaulted Electric Ovens with Electric Broilers

Oven specifications can be found on page 2

CHÂTEAU RANGETOP 120: T42

1200 W x 700 D x 200 H (mm)
 47.2 W x 27.6 D x 7.9 H (inches)
 Approx. 200 lb. uncrated, 300 lb. crated
 Choice of 8 top configurations
 Traditional 3-Element Cooktop configurations starting from \$23,800
 Traditional 4-Element with induction Cooktop configuration starting from \$29,000
 All Induction Cooktop configuration starting from \$26,200

CHATELET 120 WD: 641

1200 W x 700 D x 914 H (mm)
 47.2 W x 27.6 D x 36 H (inches)
 Approx. 500 lb. uncrated, 800 lb. crated
 Choice of 8 top configurations
 Traditional 3-Element Cooktop configuration starting from \$67,700
 Traditional 4-Element with induction Cooktop configuration starting from \$72,900
 All Induction Cooktop configuration starting from \$74,500

TRADITIONAL CHÂTEAU COOKTOP CONFIGURATION RANGES INCLUDE:
 1 Vaulted Gas Oven with Electric Broiler OR
 1 Vaulted Electric oven with Electric Broiler
 AND
 1 Electric Warming Drawer** with temperature ranging from 130 – 240 F

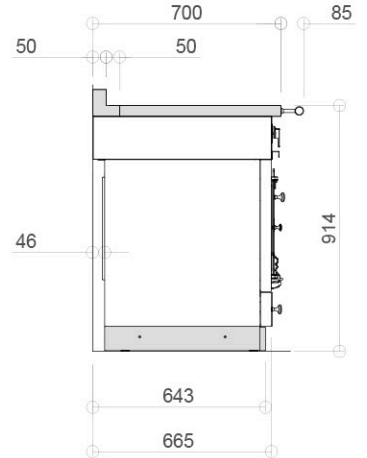
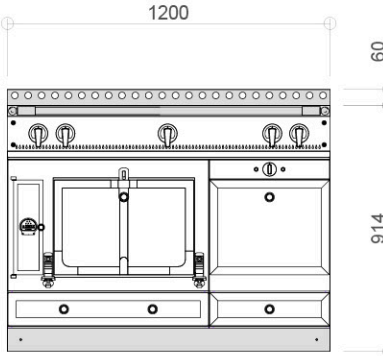
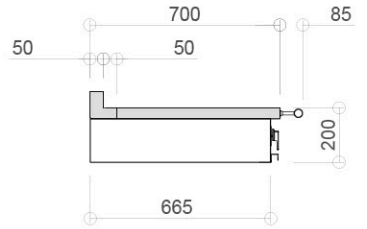
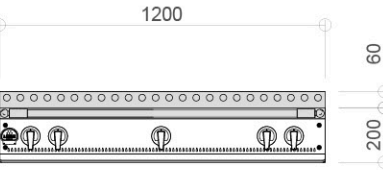
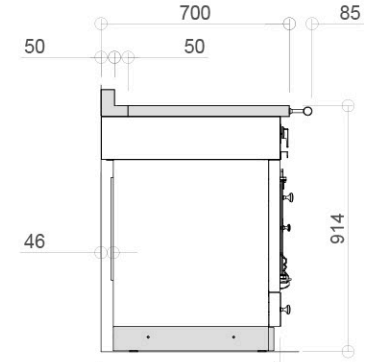
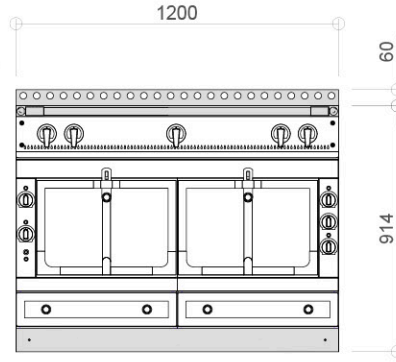

ALL INDUCTION CHÂTEAU COOKTOP CONFIGURATION RANGE INCLUDES:
 1 Vaulted Electric Oven with Electric Broilers
 AND
 1 Electric Warming Drawer** with temperature ranging from 130 – 240 F

TRADITIONAL COOKTOP CONFIGURATION OPTIONS

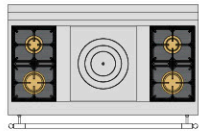

120 US E0
 2 gas burners (small burner at the back)
 1 Plaque "French Top" (large)
 2 gas burners (small burner at the back)

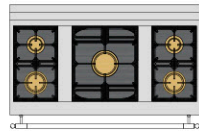

120 US E1
 2 gas burners (small burner at the back)
 1 maxi power burner
 2 gas burners (small burner at the back)



120 US E2
 2 gas burners (small burner at the back)
 1 Plaque "French Top" (large)
 1 gas lava-rock grill

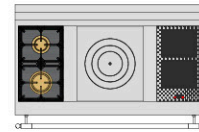

120 US E4*
 2 gas burners (small burner at the back)
 1 Plaque "French Top" (large)
 2 induction plates

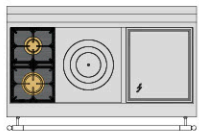

120 US E5
 2 gas burners (small burner at the back)
 1 Plaque "French Top" (large)
 1 large electric Teppanyaki

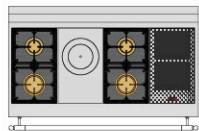

120 US ED*
 2 gas burners (small burner at the back)
 1 Plaque "French Top" (small)
 2 gas burners (small burner at the back)
 2 induction plates

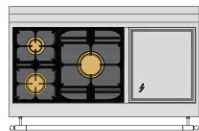

120 US EF
 2 gas burners (small burner at the back)
 1 maxi power burner
 1 large electric Teppanyaki

ALL INDUCTION COOKTOP CONFIGURATION OPTION

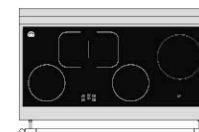

120 S E1
 Full Induction 120 Plate includes:
 2 rectangular burners - both burners can be bridged together
 2 circular burners
 1 large circular burner

CHÂTEAU 90: G49

900 W x 700 D x 914 H (mm)
 35.4 W x 27.6 D x 36 H (inches)
 Approx. 330 lb. uncrated, 600 lb. crated
 Choice of 6 top configurations
 Traditional Cooktop configurations starting from \$53,100
 All Induction Cooktop configuration starting from \$58,300

TRADITIONAL CHÂTEAU COOKTOP CONFIGURATION RANGES INCLUDE:

1 Grand Vaulted Gas Oven with Electric Broiler or
 1 Grand Vaulted Electric Oven with Electric Broiler

ALL INDUCTION CHÂTEAU COOKTOP CONFIGURATION RANGE INCLUDES:

2 Vaulted Electric Ovens with Electric Broilers

Oven specifications can be found on page 2

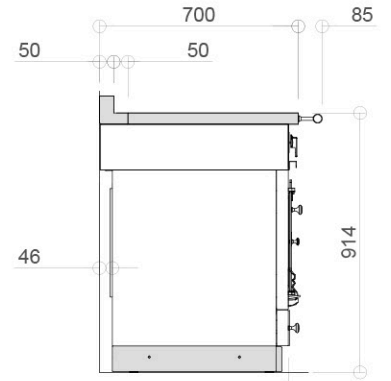
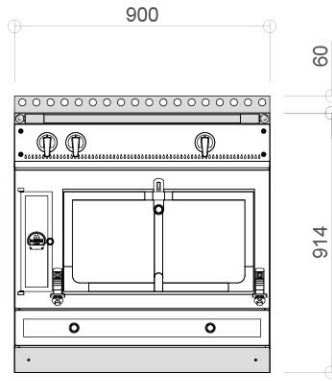

CHÂTEAU RANGETOP 90: T49

900 W x 700 D x 200 H (mm)
 35.4 W x 27.6 D x 7.9 H (inches)
 Approx. 150 lb. uncrated, 250 lb. crated
 Choice of 6 top configurations
 Traditional Cooktop configurations starting from \$22,300
 All Induction Cooktop configuration starting from \$24,600

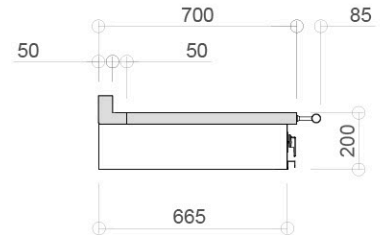
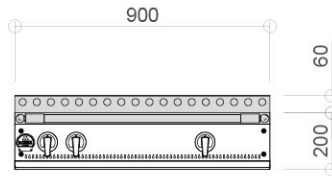

TRADITIONAL COOKTOP CONFIGURATION OPTIONS

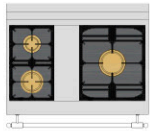

90 US C1

2 gas burners (small burner at the back)
 1 maxi power burner



90 US C2

2 gas burners (small burner at the back)
 1 Plaque "French Top" (small)
 2 gas burners (small burner at the back)

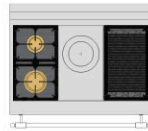

90 US C3

2 gas burners (small burner at the back)
 1 Plaque "French Top" (small)
 1 gas lava-rock grill

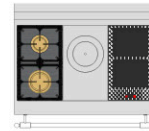

90 US C5*

2 gas burners (small burner at the back)
 1 Plaque "French Top" (small)
 2 induction plates

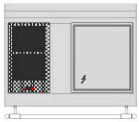

90 US CC*

2 induction plates
 1 large electric Teppanyaki

ALL INDUCTION COOKTOP CONFIGURATION OPTION

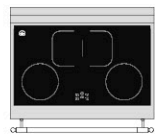

90 US CI

Full Induction 90 Plate includes:
 2 rectangular burners - both burners can be bridged together
 2 circular burners

CHÂTEAU 75: G47

750 W x 700 D x 914 H (mm)
 29.5 W x 27.6 D x 36 H (inches)
 Approx. 290 lb. uncrated, 600 lb. crated
 Choice of 5 top configurations
 All-electric range available
 Starting from \$42,000

STANDARD FEATURES INCLUDE:

1 Vaulted Gas Oven with Electric Broiler or
 1 Vaulted Electric Oven with Electric Broiler

Oven specifications can be found on page 2

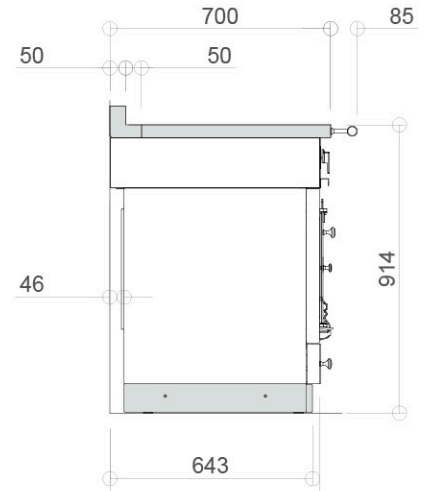
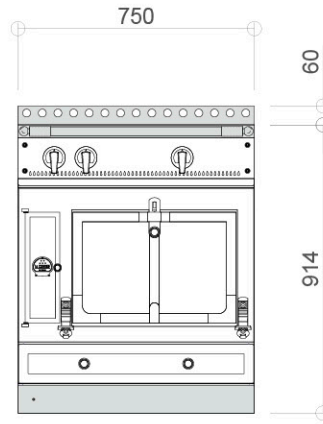

CHÂTEAU RANGETOP 75: T47

750 W x 700 D x 200 H (mm)
 29.5 W x 27.6 D x 7.9 H (inches)
 Approx. 130 lb. uncrated, 250 lb. crated
 Choice of 5 top configurations
 Starting from \$16,300

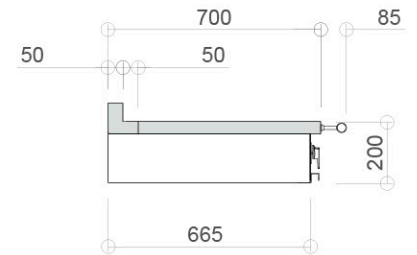
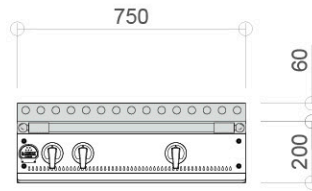

75 US B1

2 gas burners (small burner at the back)
 1 maxi power burner

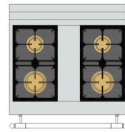

75 US B2

2 gas burners (small burner at the back)
 2 gas burners (small burner at the back)

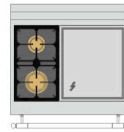

75 US B3

2 gas burners (small burner at the back)
 1 large electric Teppanyaki

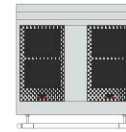

75 US BA*

2 induction plates
 2 induction plates
Induction upcharge x 2

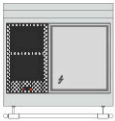

75 US BB*

2 induction plates
 1 large electric Teppanyaki

Compact Luxury, Uncompromising Performance. At just 23.6 inches wide, the Château 60 is the epitome of refined efficiency, making it the perfect choice for a chic studio apartment, pied-à-terre, guest house, or pool house. Designed for those who demand exceptional performance in a compact footprint, the Château 60 delivers timeless craftsmanship and modern innovation in perfect harmony.

CHÂTEAU 60: G40USAA

600 W x 700 D x 914 H (mm)
 23.6 W x 27.6 D x 36 H (inches)
 Approx. 331 lb. uncrated, 396 lb. crated
 Large induction hob with 4 cooking zones
 Integrated induction controls
 Electric Multifunction Convection oven
 Flushed integrated backsplash
 Starting from \$30,300

STANDARD FEATURES INCLUDE:
 1 Vaulted Electric Oven with Electric Broiler
Oven specifications can be found on page 2

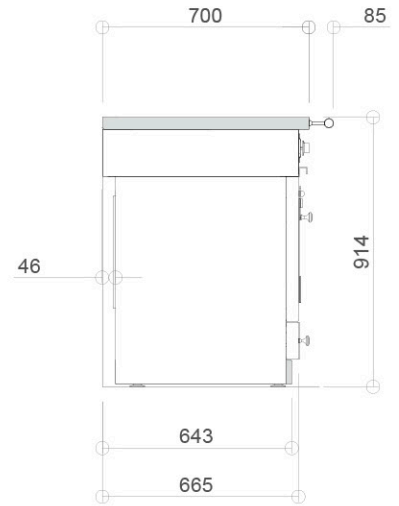
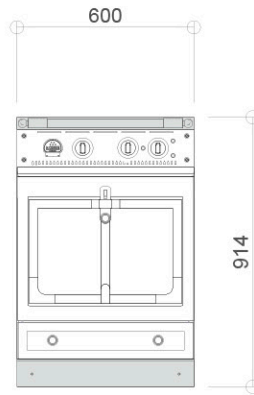

CHÂTEAU RANGETOP 60: T40USAA

600 W x 700 D x 200 H (mm)
 23.6 W x 27.6 D x 7.9 H (inches)
 Approx. 121 lb. uncrated, 165 lb. crated
 Large induction hob with 4 cooking zones
 Integrated induction controls
 Flushed integrated backsplash

Contact your La Cornue Rep for a quote

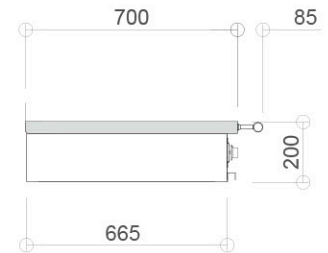
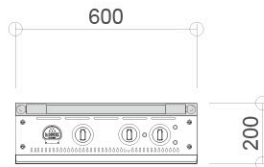

LE CHÂTEAU OPTIONS

Enamel and Metal Body Options: Château ranges are available in a variety of 50 enamel or metal body finishes, and can also be customized in a one-of-a-kind color. Prices may vary depending on colors selected.

Trim Options: Polished Brass, Brushed Brass, Brushed Stainless Steel, Brushed Nickel, Polished Chrome, Polished Copper, Matte Black, Matte Bronze, Brushed Copper and Polished Stainless Steel. Prices may vary depending on trims selected.

Despite our utmost care, slight variations may occur between color samples and the final product. These subtle differences are inherent to the handmade process and the natural mineral materials used in the enamel.

Château Tourelle Wall Oven

A fully electric multifunction platform designed to deliver premium performance without aesthetic compromise. Available in two size options, it slots cleanly into high-end kitchen environments where precision, reliability, and visual continuity matter.

Engineered to pair seamlessly with a Château Cooktop, it reinforces the cohesive design language customers expect from a luxury culinary suite. For homeowners who want the flexibility of an additional oven while maintaining the distinct Chateau Rangs aesthetic, this unit does the job without fanfare or friction. Built for serious cooking and serious style—nothing more, nothing less.

TOURELLE WALL OVEN: F75

Unit Dimensions: 747 W x 630 D x 590 H (mm)
29.4 W x 24.8 D x 23.2 (inches)

Minimum Cutout Dimensions: 724 W x 641 D x 582 H (mm)
28.5 W x 25.2 D x 22.9 (inches)

Refer to installation manual for detailed cutout dimensions

Crated Weight: 355 lbs; Uncrated Weight: 245 lbs

Voltage: 240v, 15 AMP Breaker

Available in Electric only

Starting from \$15,800

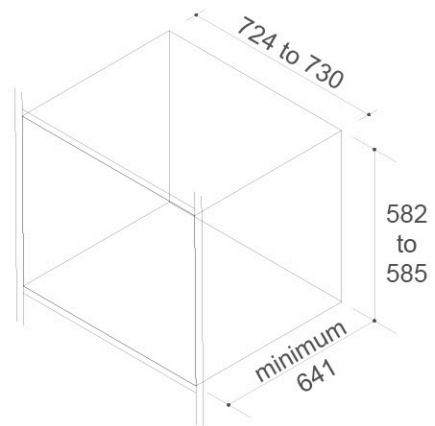
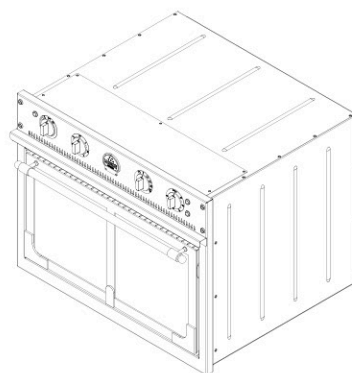
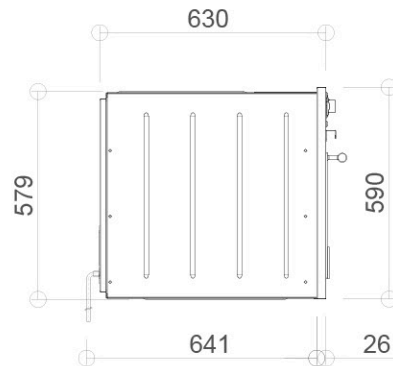
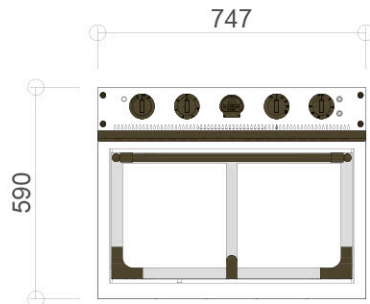

CUTOUT DIMENSIONS

TOURELLE WALL OVEN: F60

Unit Dimensions: 597 W x 630 D x 590 H (mm)
23.5 W x 24.8 D x 23.2 (inches)

Minimum Cutout Dimensions: 562 W x 641 D x 582 H (mm)
22.1 W x 25.2 D x 22.9 (inches)

Refer to installation manual for detailed cutout dimensions

Crated Weight: 310 lbs; Uncrated Weight: 200 lbs
Voltage: 240v, 15 AMP Breaker
Available in Electric only

Starting from \$10,500

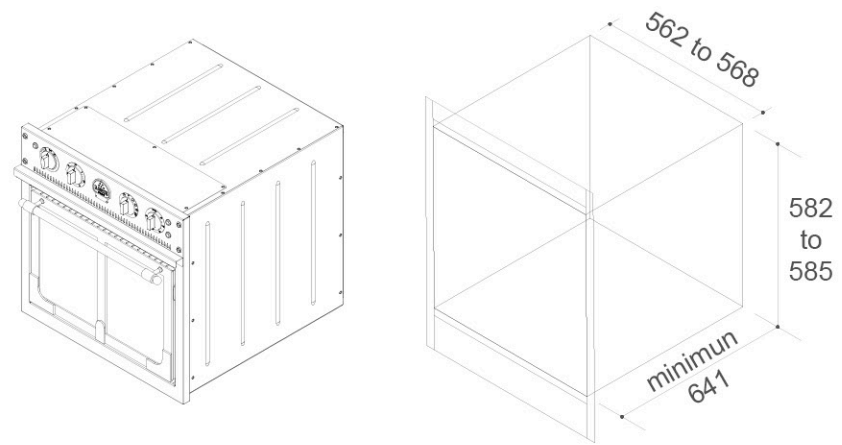
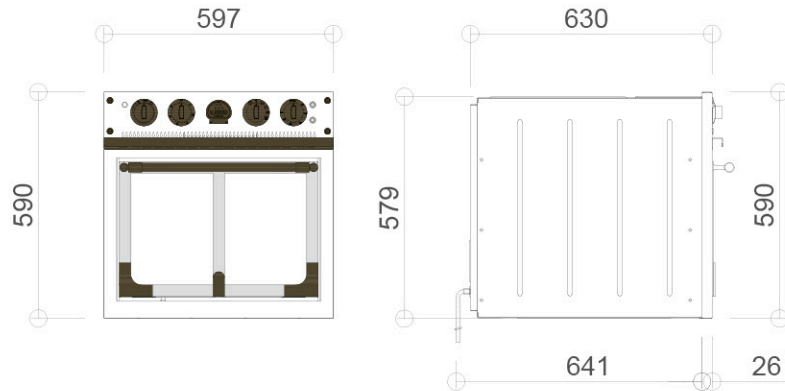

CUTOUT DIMENSIONS



LA CORNUÉ

* Teppanyaki and Induction elements incurs an upcharge of \$3,500 per element

Château Series Hoods

La Cornue offers motorized Château wall-mounted & island hood models which include a motorized factory installed blower (a 1200 CFM blower for all 2 oven cookers and a 600 CFM blower for all 1 oven cookers). In the event you choose a custom hood, La Cornue also offers hood inserts with lights, blowers and a remote control.

HOTTE CHÂTEAU

Traditional wall mounted hood. Island Hoods are also available. Custom Hoods available by quote. Hood height may be increased up to 1500 mm/ 59 inches by adding height to the upper band (total maximum height would be 2250 mm/88.5 inches). Traditional wall mounted hoods can be ordered without a blower (shell only) if using an internal or remote blower. Custom inserts available. Contact your La Cornue Sales Rep.

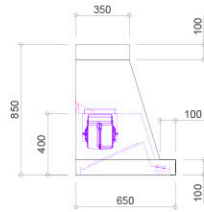

Standard Configuration Motorized Wall Hood
Side View

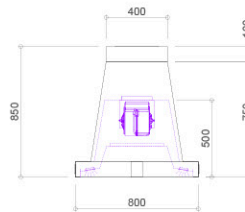

Standard Configuration Motorized Island Hood
Side View

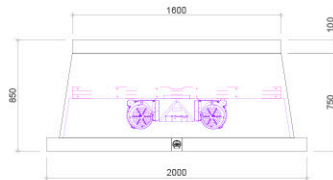

Hotte Grand Palais 180: H20T0 M
2000 W x 850 H x 650 D (mm)
78.7 W x 33.5 H x 25.6 D (inches)
Motorized Hood Starting from \$25,000

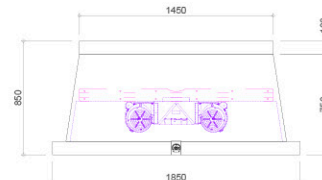

Hotte Château 165: H18T0 M
1850 W x 850 H x 650 D (mm)
72.8 W x 33.5 H x 25.6 D (inches)
Motorized Hood Starting from \$23,700

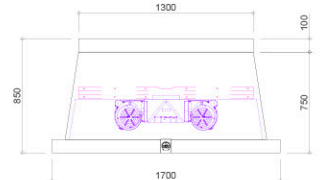

Hotte Château 150: H17T0 M
1700 W x 850 H x 650 D (mm)
66.9 W x 33.5 H x 25.6 D (inches)
Motorized Hood Starting from \$22,000

Motorized Island Hoods available - Contact your La Cornue Sales Representative for more information

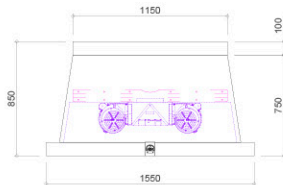

Hotte Château 135: H15T0 M
1550 W x 850 H x 650 D (mm)
61.0 W x 33.5 H x 25.6 D (inches)
Motorized Hood Starting from \$21,000

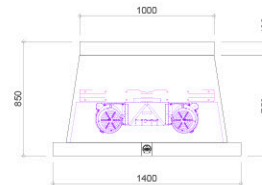

Hotte Château 120: H42T0 M
1400 W x 850 H x 650 D (mm)
55.1 W x 33.5 H x 25.6 D (inches)
Motorized Hood Starting from \$20,200

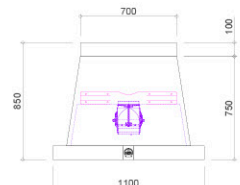

Hotte Château 90: H11T0 M
1100 W x 850 H x 650 D (mm)
43.3 W x 33.5 H x 25.6 D (inches)
Motorized Hood Starting from \$17,400

Motorized Island Hoods available - Contact your La Cornue Sales Representative for more information

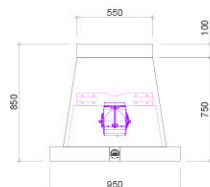

Hotte Château 75: H95T0 M
950 W x 850 H x 650 D (mm)
37.4 W x 33.5 H x 25.6 D (inches)
Motorized Hood Starting from \$16,800

Motorized Island Hoods available - Contact your La Cornue Sales Representative for more information

HOTTE CHÂTEAU WITH STRAPPING - MOTORIZED

Traditional wall mounted hood.
Custom Hood heights are available by quote.

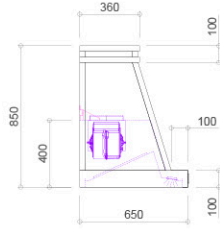

Standard Configuration Motorized Wall Hood
Side View

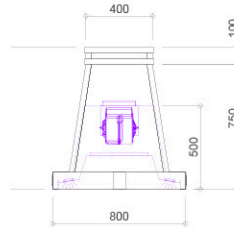

Standard Configuration Motorized Island Hood
Side View

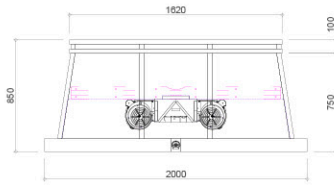

Hotte Grand Palais 180: H20T0SM
2000 W x 850 H x 650 D (mm)
78.7 W x 33.5 H x 25.6 D (inches)
Motorized Hood Starting from \$29,900

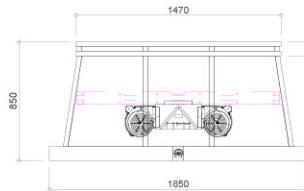

Hotte Château 165: H18T0SM
1850 W x 850 H x 650 D (mm)
72.8 W x 33.5 H x 25.6 D (inches)
Motorized Hood Starting from \$28,500

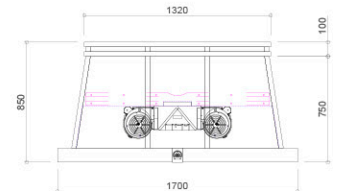

Hotte Château 150: H17T0SM
1700 W x 850 H x 650 D (mm)
66.9 W x 33.5 H x 25.6 D (inches)
Motorized Hood Starting from \$26,400

Motorized Island Hoods available - Contact your La Cornue Sales Representative for more information

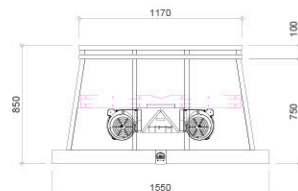

Hotte Château 135: H15T0SM
1550 W x 850 H x 650 D (mm)
61.0 W x 33.5 H x 25.6 D (inches)
Motorized Hood Starting from \$25,100

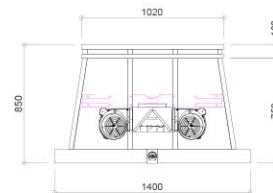

Hotte Château 120: H42T0SM
1400 W x 850 H x 650 D (mm)
55.1 W x 33.5 H x 25.6 D (inches)
Motorized Hood Starting from \$24,300

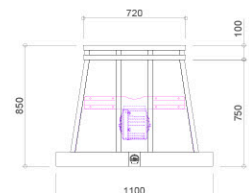

Hotte Château 90: H11T0SM
1100 W x 850 H x 650 D (mm)
43.3 W x 33.5 H x 25.6 D (inches)
Motorized Hood Starting from \$20,700

Motorized Island Hoods available - Contact your La Cornue Sales Representative for more information

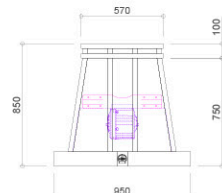

Hotte Château 75: H95T0SM
950 W x 850 H x 650 D (mm)
37.4 W x 33.5 H x 25.6 D (inches)
Motorized Hood Starting from \$20,200

Motorized Island Hoods available - Contact your La Cornue Sales Representative for more information

Château Hood Inserts

In 2020, La Cornue introduced hood inserts that are available for every size range in the Château Series. All Château inserts include an internal blower, baffle filters, LED lights, remote control, and 3 speed touch buttons for fan and light control.

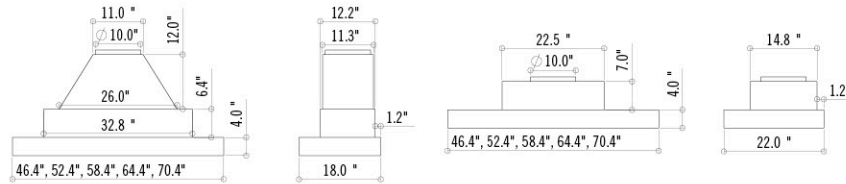

Château Hood Insert: 180LC122

Compatible with G48 & T48
70 3/8" w x 22" d Grade 304 Stainless Steel Hood Insert
Lights: 4 LED
Filters: Baffle
Internal Blower: 1200 CFM
Duct Size: 10"
Remote Control: Yes
Approx Weight: 101 lbs
Retail: \$2,550

Château Hood Insert: 165LC118

Compatible with G46 & T46
64 3/8" w x 18" d Grade 304 Stainless Steel Hood Insert
Lights: 3 LED
Filters: Baffle
Internal Blower: 1200 CFM
Duct Size: 10"
Remote Control: Yes
Approx Weight: 107 lbs
Retail: \$2,200

Château Hood Insert: 180LC118

Compatible with G48 & T48
70 3/8" w x 18" d Grade 304 Stainless Steel Hood Insert
Lights: 4 LED
Filters: Baffle
Internal Blower: 1200 CFM
Duct Size: 10"
Remote Control: Yes
Approx Weight: 119 lbs
Retail: \$2,425

Château Hood Insert: 165LC122

Compatible with G46 & T46
64 3/8" w x 22" d Grade 304 Stainless Steel Hood Insert
Lights: 3 LED
Filters: Baffle
Internal Blower: 1200 CFM
Duct Size: 10"
Remote Control: Yes
Approx Weight: 88 lbs
Retail: \$2,325

Château Hood Insert: 150LC118

Compatible with G45 & T45
58 3/8" w x 18" d Grade 304 Stainless Steel Hood Insert
Lights: 3 LED
Filters: Baffle
Internal Blower: 1200 CFM
Duct Size: 10"
Remote Control: Yes
Approx Weight: 95 lbs
Retail: \$2,000

Château Hood Insert: 150LC122

Compatible with G45 & T45
58 3/8" w x 22" d Grade 304 Stainless Steel Hood Insert
Lights: 3 LED
Filters: Baffle
Internal Blower: 1200 CFM
Duct Size: 10"
Remote Control: Yes
Approx Weight: 75 lbs
Retail: \$2,100

Château Hood Insert: 135LC118

Compatible with G43 & T43
52 3/8" w x 18" d Grade 304 Stainless Steel Hood Insert
Lights: 3 LED
Filters: Baffle
Internal Blower: 1200 CFM
Duct Size: 10"
Remote Control: Yes
Approx Weight: 83 lbs
Retail: \$1,875

Château Hood Insert: 135LC122

Compatible with G43 & T43
52 3/8" w x 22" d Grade 304 Stainless Steel Hood Insert
Lights: 3 LED
Filters: Baffle
Internal Blower: 1200 CFM
Duct Size: 10"
Remote Control: Yes
Approx Weight: 71 lbs
Retail: \$2,000

Château Hood Insert: 120LC118

Compatible with G42, G41 & T42
46 3/8" w x 18" d Grade 304 Stainless Steel Hood Insert
Lights: 3 LED
Filters: Baffle
Internal Blower: 1200 CFM
Duct Size: 10"
Remote Control: Yes
Approx Weight: 71 lbs
Retail: \$1,775

Château Hood Insert: 120LC122

Compatible with G42, G41 & T42
46 3/8" w x 22" d Grade 304 Stainless Steel Hood Insert
Lights: 3 LED
Filters: Baffle
Internal Blower: 1200 CFM
Duct Size: 10"
Remote Control: Yes
Approx Weight: 67 lbs
Retail: \$1,900

Château Hood Insert: 90LC118

Compatible with G49 & T49
34 3/8" w x 18" d Grade 304 Stainless Steel Hood Insert
Lights: 2 LED
Filters: Baffle
Internal Blower: 600 CFM
Duct Size: 8"
Remote Control: Yes
Approx Weight: 40 lbs
Retail: \$1,225

Château Hood Insert: 90LC122

Compatible with G49 & T49
34 3/8" w x 22" d Grade 304 Stainless Steel Hood Insert
Lights: 2 LED
Filters: Baffle
Internal Blower: 600 CFM
Duct Size: 8"
Remote Control: Yes
Approx Weight: 46 lbs
Retail: \$1,550

Château Hood Insert: 75LC118

Compatible with G47 & T47
28 3/8" w x 18" d Grade 304 Stainless Steel Hood Insert
Lights: 2 LED
Filters: Baffle
Internal Blower: 600 CFM
Duct Size: 8"
Remote Control: Yes
Approx Weight: 36 lbs
Retail: \$1,225

CHÂTEAU ENAMEL COLORS

Despite our utmost care, slight variations may occur between color samples and the final product. These subtle differences are inherent to the handmade process and the natural mineral materials used in the enamel.

STANDARD COLORS *(included in listed prices)*

M	Brilliant Black
D	Dark Navy Blue
N	Matte Black
r	Royal Blue
I	Stainless Steel

PREMIUM COLORS *(additional charge)*

Y	Almond Green
V	Antique White
F	Antique White w/ Flowers
H	Azulejo Blue
Z	Imperial Green <i>(formerly known as British Racing Green)</i>
c	Chocolate
k	Cocoa
B	French Blue
e	Greige
j	Icy Blue
U	Lafayette Blue
L	Lavender Blue
I	Milk White/Lacté
n	Moss Green
g	Pebble Grey (Matte)
P	Pistachio
W	Pure White
u	Quintessential Teal (Brilliant)
s	Quintessential Teal (Matte)
T	Rush Green
E	Summer Blue
h	Truffle
5	Ultra Black
v	Basilica
4	Blanc
i	Pasture
x	Provincial
G	Roquefort
a	Roux (Matte)
z	Sovereign

PREMIUM COLORS *continued*

6	Tapestry
9	Tranquille
jw	Jerez White
gb	Goodwood Blue
gg	Grand Prix Grey
mg	Monaco Grey
ss	Silverstone Noir
sn	Sarthe Noir
oc	Ocean
ws	Wintersky
gr	Graphite
10	Montagne
1	Amber
2	Peacock
S	Custom Color

DELUXE COLORS *(additional charge)*

m	Aquamarine Blue
w	Matte White
K	Sahara Sand

PREMIUM DELUXE COLORS *(additional charge)*

C	Copper (Brushed)
d	Pebbled Stainless
8	Berry

PRICED TO QUOTE

X	Carbon Fiber <i>(special premium deluxe pricing applies)</i>
----------	--

WOOD CABINETRY

EPI and EPH are available, light oak, dark walnut, wrapped in stainless steel, copper or painted to match the range.

COLORED TOE KICK TO MATCH THE RANGE

Château 180	\$ 2,300.00
Château 165	\$ 2,200.00
Château 150	\$ 2,100.00
Chatelet 135	\$ 2,000.00
Château 120	\$ 1,900.00
Chatelet 120	\$ 1,900.00
Château 90	\$ 1,700.00
Château 75	\$ 1,500.00
Château 60	\$ 1,500.00

Château Series Color & Trim Options

La Cornue ranges, cooktops, hoods, cabinets and accessories are available in a variety of solid metal trim with living finishes, which patina naturally over time. For an additional cost, clear coated varnish available. Below is a pictorial diagram of the various trim options La Cornue offers.

TRIM, ACCENT & RAIL LOCATIONS

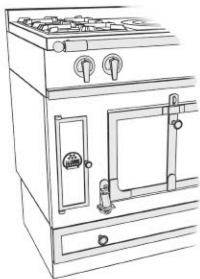

B: Polished Brass Trim
L: Brushed Brass Trim
K: Polished Copper Trim

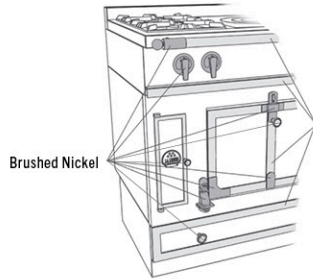

N: Brushed Stainless Steel & Brushed Nickel
H: Matte Bronze Trim

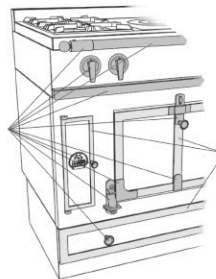

Y: Polished Brass & Brushed Stainless Steel
R: Polished Copper & Brushed Stainless Steel

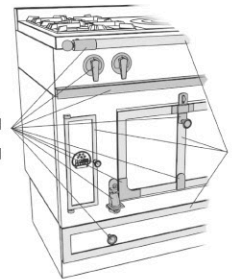

D: Polished Brass & Brushed Stainless Steel with Brushed Stainless Handrail
V: Polished Copper & Brushed Stainless Steel with Brushed Stainless Handrail

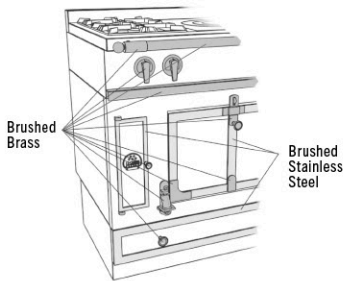

S: Brushed Brass & Stainless Steel
J: Matte Black Trim

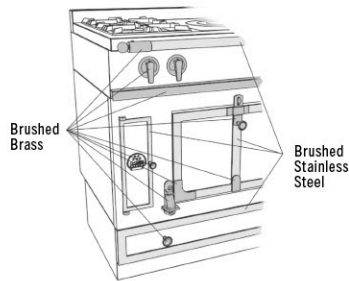

A: Brushed Brass & Stainless Steel with Brushed Stainless Handrail
H: Matte Bronze Trim

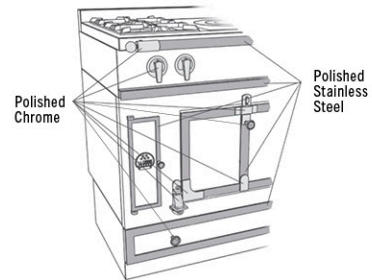

C: Polished Chrome & Polished Stainless Steel
J: Matte Black Trim

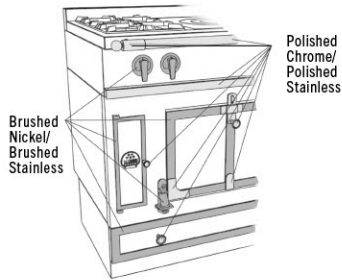

M: Brushed Nickel/Brushed Stainless & Polished Chrome/Polished Stainless
J: Matte Black Trim

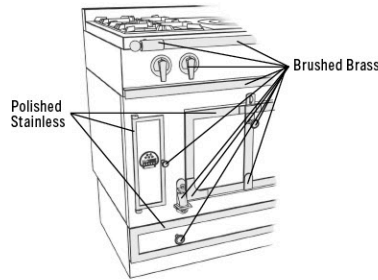

P: Polished Stainless & Brushed Brass with Brushed Brass Handrail
J: Matte Black Trim

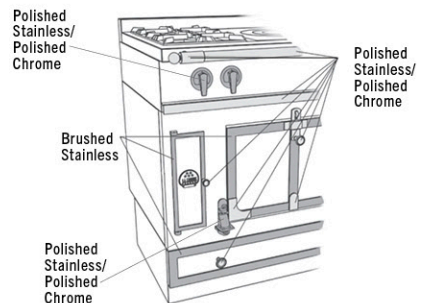

Q: Polished Chrome & Brushed Stainless Steel with Polished Stainless Steel Handrail
J: Matte Black Trim

CHÂTEAU TRIM OPTIONS (Note: All metals are natural metals and will patina over time. Clear coated varnish trims are available for the Château line only.)

STANDARD TRIMS (included in listed prices)

Trim	Accents	Rails
S Brushed Stainless Steel	Brushed Brass	Brushed Brass
Y Brushed Stainless Steel	Polished Brass	Polished Brass
A Brushed Stainless Steel	Brushed Brass	Brushed Stainless Steel
D Brushed Stainless Steel	Polished Brass	Brushed Stainless Steel
B Polished Brass	Polished Brass	Polished Brass
L Brushed Brass	Brushed Brass	Brushed Brass
N Brushed Stainless Steel	Brushed Nickel	Brushed Stainless Steel
M Brushed Stainless Steel	Polished Chrome/ Brushed Nickel	Polished Stainless Steel

PREMIUM TRIMS (additional charge)

Trim	Accents	Rails
J Matte Black	Matte Black	Matte Black
H Bronze	Bronze	Bronze
C Polished Stainless Steel	Polished Chrome	Polished Stainless Steel
O Brushed Stainless Steel	Polished Chrome	Polished Stainless Steel
P Polished Stainless Steel	Brushed Brass	Brushed Brass

COPPER TRIMS (additional charge)

Trim	Accents	Rails
V Brushed Stainless Steel	Polished Copper	Brushed Stainless Steel
K Polished Copper	Polished Copper	Polished Copper
R Brushed Stainless Steel	Polished Copper	Polished Copper
k Brushed Copper	Brushed Copper	Brushed Copper

Combine any La Cornue Trim options to create your own unique combination.

FLAMBERGE RÔTISSERIE TRIM OPTIONS

Trim	Knobs
S Brushed Stainless Steel	Brushed Brass
Y Brushed Stainless Steel	Polished Brass
N Brushed Stainless Steel	Brushed Nickel
B Polished Brass	Polished Brass
L Brushed Brass	Brushed Brass
C Polished Stainless Steel	Polished Chrome
O Brushed Stainless Steel	Polished Chrome
J Matte Black	Matte Black
H Bronze	Bronze
P Polished Stainless Steel	Brushed Brass
R Brushed Stainless Steel	Polished Copper
K Polished Copper	Polished Copper

Rod supports are always in Polished Aluminum

Contact your La Cornue Rep to obtain an interactive custom trim form. Custom trims should be priced under Copper price category regardless if Copper is chosen.

CHÂTEAU I.D. PLATE

Château 180, 165, 150

2 I.D. Plates 2 Lines per I.D. Plate,
15 Characters per line

Château 135, 120, 90, 75, 60 rangetops, Flamberge & Hotte Château Hoods

1 I.D. Plate 2 Lines per I.D. Plate,
15 Characters per line

STANDARD

PREMIUM

COPPER

Château Suprême by Ferris Rafauli

The Château range is an icon of the French art of living throughout the world. Reimagined by Ferris Rafauli, this contemporary version is the ultimate in sophistication. To create it, the designer considered and revised each element of the range to bring out its most distinctive characteristics, taking the precision of the lines and details to a whole new level.

CHÂTEAU SUPRÊME GRAND PALAIS 180

1800 W x 700 D x 914 H (mm)
70.9 W x 27.6 D x 36 H (inches)
Approx. 710 lb. uncrated, 1320 lb. crated

OPTIONS:

- Two optional warming drawer cabinets, each featuring an electric teppanyaki or stainless steel tops
- Six cooktop configurations
- Château Suprême 180 hood, finished to match the range, or in an optional leather-covered exterior

OVENS:

1 Grand Vaulted Gas Oven with Electric Broiler
22.6W x 19.8D x 11.8H – 3.1 cubic feet (left)
1 Grand Vaulted Electric Oven with Electric Broiler
22.6W x 17.5D x 11.8H – 2.7 cubic feet (right)
Includes: interior lighting, CLEANemail coating, one electric grill and an oven kit (one large grill, one drip pan, one porcelain roasting dish, one raised grill)

Starting from \$229,000

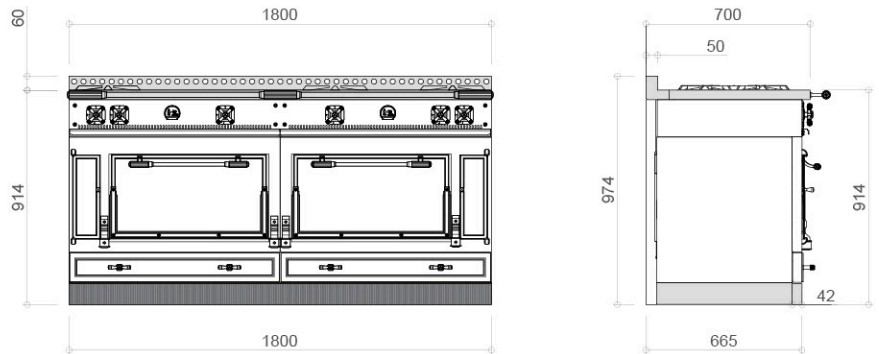

CHÂTEAU SUPRÊME WARMING DRAWER

Two optional warming drawer cabinets, each featuring an electric teppanyaki top or stainless steel tops
Top storage drawer
One large warming drawer with sliding shelf
Warming Drawer weight limit per shelf: 110 pounds
Temperature: 130°F to 240°F (*ideal for slow cooking*)

Electric Teppanyaki Top — Starting from \$105,300 (Qty 2)

Stainless Steel Top — Starting from \$82,100 (Qty 2)

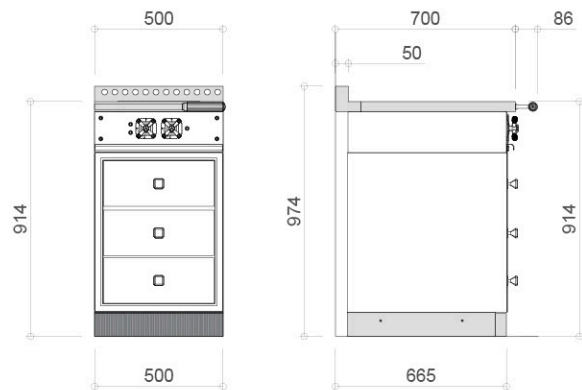

500 W x 665 D x 920 H (mm)
19.7 W x 26.2 D x 36.2 H (inches)
Approx. 200 lb. uncrated, 680 lb. crated
240 Volts

DETAILS EXCLUSIVE TO ALL CHÂTEAU SUPRÊME RANGES:

- Iconic La Cornue – Ferris Rafauli brand plate
- Four new Château Suprême Colors developed by Ferris Rafauli exclusively for this range, including FR Blue, Essex Green, California Blue and Cloud Gray, as well as being available in most existing Château finishes
- The Ferris Exclusive Trims are the **ONLY** trim options available on the Château Suprême Range (*Polished Brass and Polished Nickel or Brushed Nickel) *Clear Coated Varnish
- Burners and French Top engraved with the La Cornue stars
- Solid walnut chopping block with stainless steel cradle included with all SPE configurations featuring the Lava Rock Grill
- Designer dual-finish control knobs
- Art Deco inspired bezels and toe kick featuring individually aligned moulded bars

CHÂTEAU SUPRÊME 150

1500 W x 700 D x 914 H (mm)

59.1 W x 27.6 D x 36 H (inches)

Approx. 620 lb. uncrated, 1230 lb. crated

OPTIONS:

- Two optional warming drawer cabinets, each featuring an electric teppanyaki top or stainless steel tops
- Three cooktop configurations
- Château Suprême 150 hood, finished to match the range, or in an optional leather-covered exterior

OVENS:

1 Vaulted Gas Oven with Electric Broiler 16.8W x 19.8D x 11.8H – 2.3 cubic feet (left)

1 Vaulted Electric Oven with Electric Broiler 16.8W x 17.5D x 11.8H – 2.0 cubic feet (right)

Includes: interior lighting, CLEANemail coating, one electric grill and an oven kit (one large grill, one drip pan, one porcelain roasting dish, one raised grill)

Starting from \$223,900

CHÂTEAU SUPRÊME WARMING DRAWER

Two optional warming drawer cabinets, each featuring an electric teppanyaki top or stainless steel tops

Top storage drawer

One large warming drawer with sliding shelf

Warming Drawer weight limit per shelf: 110 pounds

Temperature: 130°F to 240°F (*ideal for slow cooking*)

Electric Teppanyaki Top — Starting from \$105,300 (Qty 2)

Stainless Steel Top — Starting from \$82,100 (Qty 2)

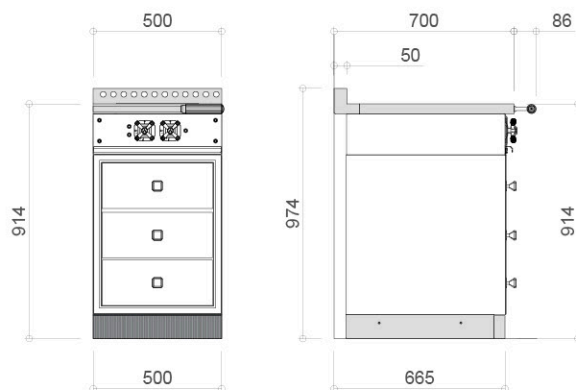
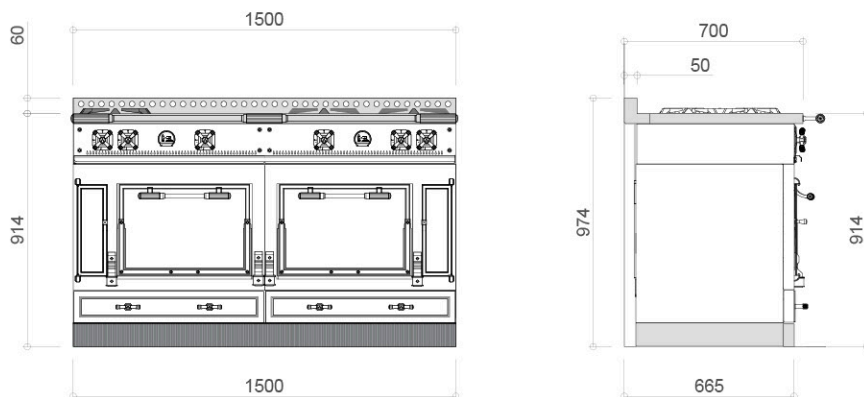

500 W x 665 D x 920 H (mm)

19.7 W x 26.2 D x 36.2 H (inches)

Approx. 200 lb. uncrated, 680 lb. crated

240 Volts

DETAILS EXCLUSIVE TO ALL CHÂTEAU SUPRÊME RANGES:

- Iconic La Cornue – Ferris Rafauli brand plate
- Four new Château Suprême Colors developed by Ferris Rafauli exclusively for this range, including FR Blue, Essex Green, California Blue and Cloud Gray, as well as being available in most existing Château finishes
- The Ferris Exclusive Trims are the **ONLY** trim options available on the Château Suprême Range (*Polished Brass and Polished Nickel or Brushed Nickel) *Clear Coated Varnish
- Burners and French Top engraved with the La Cornue stars
- Solid walnut chopping block with stainless steel cradle included with all SPE configurations featuring the Lava Rock Grill
- Designer dual-finish control knobs
- Art Deco inspired bezels and toe kick featuring individually aligned moulded bars
- ID Plates (2 ID plates)
- I.D. Plate 1 Line per I.D. Plate,
- 15 Characters per line

Château Suprême by Ferris Rafauli

CHATEAU SUPRÊME GRAND PALAIS 180 RANGETOP CONFIGURATIONS: G48FR



- 180 N1**
 2 gas burners (small burner at the back)
 1 Plaque "French Top" (large)
 1 maxi (power) burner
 2 gas burners (small burner at the back)

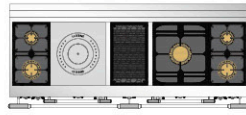

- 180 N1 SPE**
 2 gas burners (small burner at the back)
 1 Plaque "French Top" (large)
 1 1 gas lava-rock grill
 1 maxi (power) burner
 2 gas burners (small burner at the back)
 Walnut chopping block

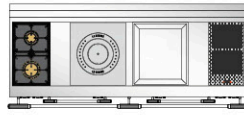

- 180 N2**
 2 gas burners (small burner at the back)
 1 Plaque "French Top" (large)
 1 large electric Teppanyaki
 2 induction plates



- 180 N2 SPE**
 2 gas burners (small burner at the back)
 1 Plaque "French Top" (large)
 1 gas lava-rock grill
 1 large electric Teppanyaki
 2 induction plates
 Walnut chopping block

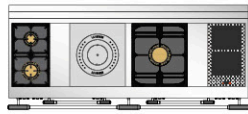

- 180 NM**
 2 gas burners (small burner at the back)
 1 Plaque "French Top" (large)
 1 maxi (power) burner
 2 induction plates



- 180 NM SPE**
 2 gas burners (small burner at the back)
 1 Plaque "French Top" (large)
 1 gas lava-rock grill
 1 maxi (power) burner
 2 induction plates
 Walnut chopping block

CHATEAU SUPRÊME 150 RANGETOP CONFIGURATIONS: G45FR

* *Teppanyaki and Induction are inclusive of price.*

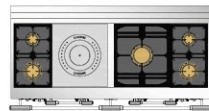

- 150 K1**
 Change to:
 2 gas burners (small burner at the back)
 1 Plaque "French Top" (large)
 1 maxi (power) burner
 2 gas burners (small burner at the back)

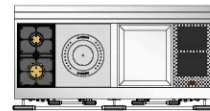

- 150 K2**
 2 gas burners (small burner at the back)
 1 Plaque "French Top" (large)
 1 large electric Teppanyaki
 2 induction plates

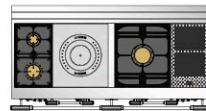

- 150 KM**
 2 Gas burners
 1 Large Plaque "French Top"
 1 power burner
 2 Induction Plates

CHATEAU SUPRÊME HOODS:

CHATEAU SUPRÊME HOOD 180

- 2012 W x 656 D x 1568 H (mm)
 79.2 W x 25.8 D x 61.7 H (inches)
 Weight: 728 lbs
 6 Baffle Filters
 6 LED Lights
 1200 CFM Internal Blower
 Starting from \$66,000

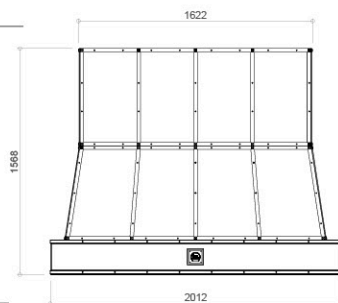

CHATEAU SUPRÊME 180 HOOD

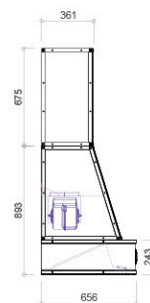

CHATEAU SUPRÊME 150 HOOD

CHATEAU SUPRÊME HOOD 150

- 1712 W x 656 D x 1568 H (mm)
 67.4 W x 25.8 D x 61.7 H (inches)
 Weight: 684 lbs
 3 Baffle Filters
 5 LED Lights
 1200 CFM Internal Blower
 Starting from \$58,900

- ID PLATE (1 ID PLATE)**
 I.D. Plate 1 Line,
 15 Characters per line

Château Moderne by Matthew Quinn

CHÂTEAU MODERNE 180: G48MQ & G48MQH

1800 W x 700 D x 920 H (mm)
70.9 W x 27.6 D x 36 H (inches)
Approx. 710 lb. uncrated, 1320 lb. crated

OPTIONS:

- Available in full body color, hand hammered satin chrome, hand hammered satin brass
- Available in any trim
- Unique Flushed Backsplash (Raised Backsplash available for an additional charge)

OVENS:

1 Grand Vaulted Gas Oven with Electric Broiler
22.6W x 19.8D x 11.8H – 3.1 cubic feet (left)
1 Grand Vaulted Electric Oven with Electric Broiler
22.6W x 17.5D x 11.8H – 2.7 cubic feet (right)
Includes: interior lighting, CLEANemail coating, one electric grill and an oven kit (one large grill, one drip pan, one porcelain roasting dish, one raised grill)

Starting from \$124,200
\$149,100 w/ hand hammered finish

ID Plates (1 ID plate)

I.D. Plate 1 Line
15 Characters per line

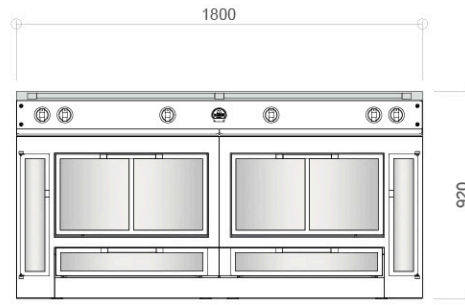

CHÂTEAU MODERNE 180

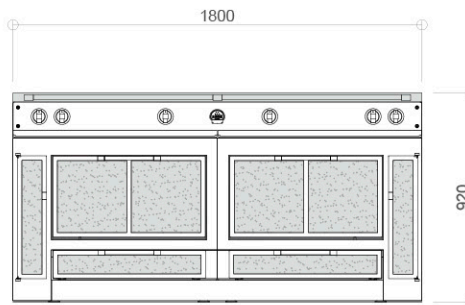

CHÂTEAU MODERNE 180
HAND-HAMMERED FINISH

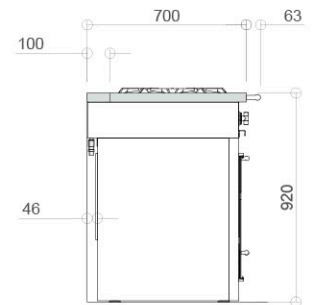
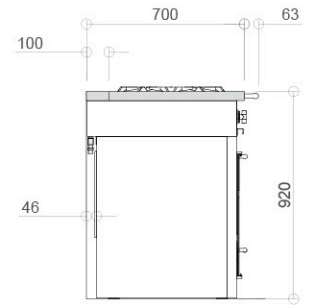

CHÂTEAU MODERNE 180 RANGETOP CONFIGURATIONS

* *Teppanyaki and Induction are inclusive of price.*

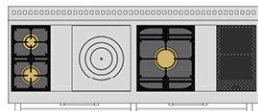

180 US N1

2 gas burners (small burner at the back)
1 Plaque "French Top" (large)
1 maxi (power) burner
2 induction plates

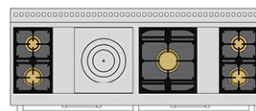

180 US N2

2 gas burners (small burner at the back)
1 Plaque "French Top" (large)
1 maxi (power) burner
2 gas burners (small burner at the back)

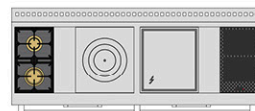

180 US N3

2 gas burners (small burner at the back)
1 Plaque "French Top" (large)
1 maxi (power) burner
1 large electric Teppanyaki

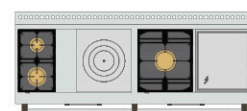

180 US N4

2 gas burners (small burner at the back)
1 Plaque "French Top" (large)
1 maxi (power) burner
1 large electric Teppanyaki



180 US N5

2 gas burners (small burner at the back)
1 Plaque "French Top" (large)
2 gas burners (small burner at the back)
1 gas lava-rock grill
1 large electric Teppanyaki

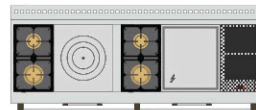

180 US N6

2 gas burners (small burner at the back)
1 Plaque "French Top" (large)
2 gas burners (small burner at the back)
1 large electric Teppanyaki
2 induction plates



180 US N7

2 gas burners (small burner at the back)
1 Plaque "French Top" (large)
2 gas burners (small burner at the back)
1 large electric Teppanyaki

Château Moderne by Matthew Quinn

CHÂTEAU MODERNE 150: G45MQ & G45MQH

1500 W x 700 D x 920 H (mm)
 59.1 W x 27.6 D x 36 H (inches)
 Approx. 620 lb. uncrated, 1230 lb. crated

OPTIONS:

- Available in full body color, hand hammered satin chrome, hand hammered satin brass
- Available in any trim
- Unique Flushed Backsplash (Raised Backsplash available for an additional charge)

OVENS:

1 Vaulted Gas Oven with Electric Broiler 16.8W x 19.8D x 11.8H – 2.3 cubic feet (left)
 1 Vaulted Electric Oven with Electric Broiler 16.8W x 17.5D x 11.8H – 2.0 cubic feet (right)
Includes: interior lighting, CLEANemail coating, one electric grill and an oven kit (one large grill, one drip pan, one porcelain roasting dish, one raised grill)

Starting from \$107,900
 \$129,600 w/ hand hammered finish

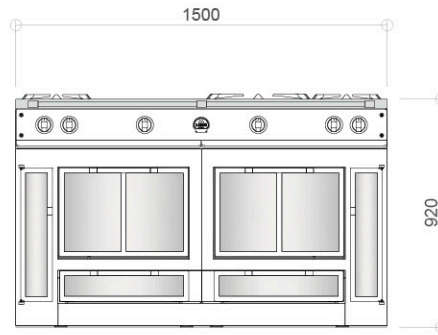

CHÂTEAU MODERNE 150

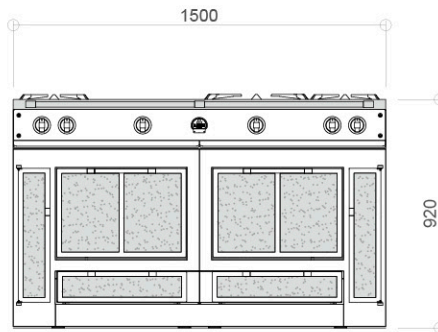
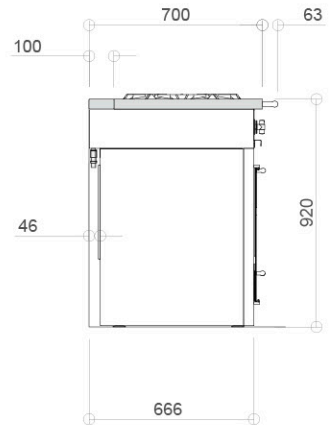

CHÂTEAU MODERNE 150
 HAND-HAMMERED FINISH

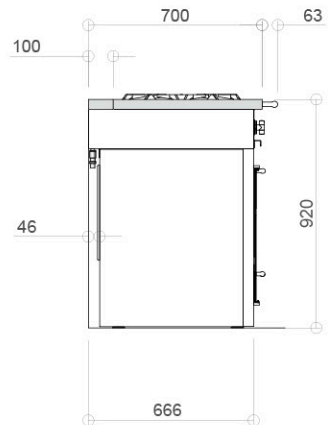

CHÂTEAU MODERNE 150 RANGETOP CONFIGURATIONS

* *Teppanyaki and Induction are inclusive of price.*

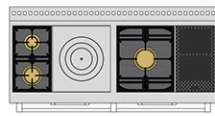

150 US KM
 2 gas burners (small burner at the back)
 1 Plaque "French Top" (large)
 1 maxi (power) burner
 2 Induction Plates

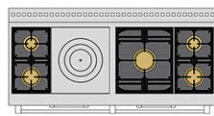

150 US K1
 2 gas burners (small burner at the back)
 1 Plaque "French Top" (large)
 1 maxi (power) burner
 2 gas burners (small burner at the back)

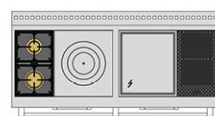

150 US K2
 2 gas burners (small burner at the back)
 1 Plaque "French Top" (large)
 1 large electric Teppanyaki
 2 induction plates

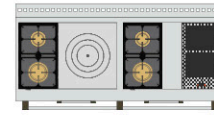

150 US K3
 2 gas burners (small burner at the back)
 1 Plaque "French Top" (large)
 2 gas burners (small burner at the back)
 2 induction plates

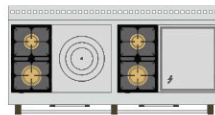

150 US K4
 2 gas burners (small burner at the back)
 1 Plaque "French Top" (large)
 2 gas burners (small burner at the back)
 1 large electric Teppanyaki

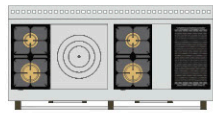

150 US K5
 2 gas burners (small burner at the back)
 1 Plaque "French Top" (large)
 2 gas burners (small burner at the back)
 1 gas lava-rock grill



150 US KH
 2 gas burners (small burner at the back)
 1 Plaque "French Top" (large)
 1 gas lava-rock grill
 1 large electric Teppanyaki

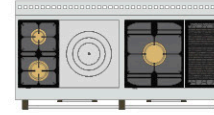

150 US K6
 2 gas burners (small burner at the back)
 1 Plaque "French Top" (large)
 1 maxi (power) burner
 1 gas lava-rock grill

CornuFé Series

In 2005, the CornuFé Series was born, introducing La Cornue to a whole new generation. For those who hate to wait, units are inventoried stateside, and are available in eleven colors with three accent options. Designed with the American kitchen in mind, the CornuFé Series features electric multi-function convection ovens and either robust brass burners or induction.

CORNUFÉ 110: c1

1092 W x 650 D x 910 (937 max) H (mm)
 43 W x 25.6 D x 35.8 (36.9 max) H (inches)
 350 lb. uncrated, 465 lb. crated
 High-performance 5 burner gas cooktop
 Double electric convection ovens
 Classic Color Retail: \$14,205
 Suzanne Kasler Color Collection Retail: \$14,975
 Étoilé Color Retail: \$14,975
 Limited Edition: \$16,335

SPECIFICATIONS:

Gas Burners:

1 17,500 BTU Central Burner
 3 12,000 BTU Burners
 1 6,000 BTU Simmer Burner
 Solid Brass Burners Enamel-Capped with Thermocouple Safety Mechanism

Ovens:

French side-swing enameled steel doors
 2 Electric Convection Ovens, one of which features 7 cooking modes
 4 Interior Oven Racks Included (2 flat racks, 2 dropped racks)
 2 Enamel Baking Trays and 1 Trivet
 Left Oven: 430 W x 370 D x 380 H (mm)
 16.9 W x 14.6 D x 15 H (inches)
 2.2 cubic feet
 Right Oven: 430 W x 370 D x 410 H (mm)
 16.9 W x 14.6 D x 16.2 H (inches)
 2.39 cubic feet

Range Accessories: Plaque Adaptor Kit, Wok Ring,
 Grill/Griddle Plate, Brass Burners

Power and Fuel:

Voltage: 240v; 60Hz, 30 AMP Breaker
 Gas connection: 1/2 inch NPT at rear right-hand side
 Natural gas range with propane conversion kit included
 High-Altitude Kit required for elevations above 5,000 feet
 Natural Gas High-Altitude Kit "A037977": Retail for \$65
 Propane High-Altitude Kit "A037982": Retail for \$65

Available Finishes:

Classic Colors: Matte Black, Stainless Steel, Gloss Black,
 Provence Blue, and Pure White
 Étoilé Colors: Morning Dew, Graphite, Ocean, and Wintersky
 Suzanne Kasler
 Colors: Tapestry and Roquefort
 Custom Colors
 & Trims: Consult your La Cornue Sales Rep for more information.

Three Trim Options: Stainless Steel Trim and Rail with
 Satin Chrome Accents
 Stainless Steel Trim with Polished Brass Rail
 and Accents
 Stainless Steel Trim, Polished Stainless Steel Rail, with
 Polished Chrome Accents

NOTE: Side panels are stainless steel for all colors except Gloss Black, Matte Black ranges have flat black side panels. The Polished Brass Trim is natural, non coated metal and will patina over time.

For coordinating hoods, please see Page 24.

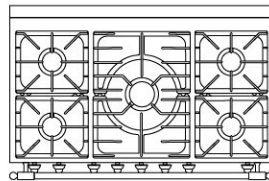
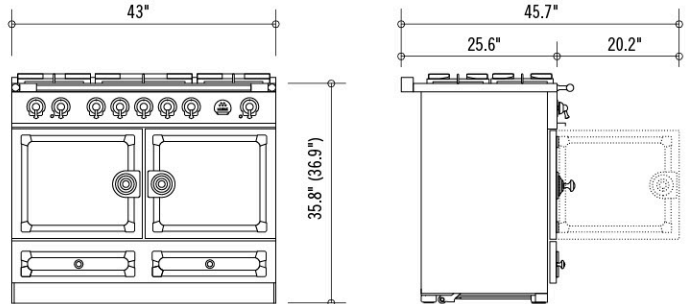

Limited Edition / Designer Series:

Martyn Lawrence Bullard
 Brands Hatch Green
 Goodwood Blue

Matthew Quinn
 Quintessential Teal (Gloss)
 Quintessential Orange

Available in two trims ONLY:

Stainless & Brushed Brass
 Stainless & Polished Brass

CORNUFÉ 110 INDUCTION: C1-I

1092 W x 720 D x 915 (942 max) H (mm)
 43 W x 28.6 D x 36.3 (36.9 max) H (inches)
 350 lb. uncrated 465 lb. crated
 High-performance 5 zone induction cooktop
 Double electric convection ovens
 Classic Color Retail: \$15,915
 Suzanne Kasler Color Collection Retail: \$16,775
 Étoilé Color Retail: \$16,775
 Limited Edition: \$18,305

SPECIFICATIONS:

Induction Cooktop ratings:

Front Left: 1.4 kW (Max) 2.2 kW (Boost)

Rear Left: 1.85 kW (Max) 3.0 kW (Boost)

Center: 2.3 kW (Max) 3.7 kW (Boost)

Front Right: 1.85 kW (Max) 3.0 kW (Boost)

Rear Right: 1.85 kW (Max) 3.0 kW (Boost)

Ovens:

French side-swing enameled steel doors

2 Electric Convection Ovens, one of which features 7 cooking modes

4 Interior Oven Racks Included (2 flat racks, 2 dropped racks)

2 Enamel Baking Trays and 1 Trivet

Left Oven: 430 W x 370 D x 380 H (mm)
 16.9 W x 14.6 D x 15 H (inches)
 2.2 cubic feet

Right Oven: 430 W x 370 D x 410 H (mm)
 16.9 W x 14.6 D x 16.2 H (inches)
 2.39 cubic feet

Power and Fuel:

Voltage: 240v; 60Hz, 50 AMP Breaker

Available Finishes:

Classic Colors: Matte Black, Stainless Steel, Gloss Black,
 Provence Blue, and Pure White

Étoilé Colors: Morning Dew, Graphite, Ocean, and Wintersky

Suzanne Kasler

Colors: Tapestry and Roquefort

Custom Colors

& Trims: Consult your La Cornue Sales Rep for more information.

Three Trim Options: Stainless Steel Trim and Rail with
 Satin Chrome Accents

Stainless Steel Trim with Polished Brass Rail
 and Accents

Stainless Steel Trim, Polished Stainless Steel Rail, with
 Polished Chrome Accents

NOTE: Side panels are stainless steel for all colors except Gloss Black, Matte Black ranges have flat black side panels. The Polished Brass Trim is natural, non-coated metal and will patina over time.

For coordinating hoods, please see Page 24.

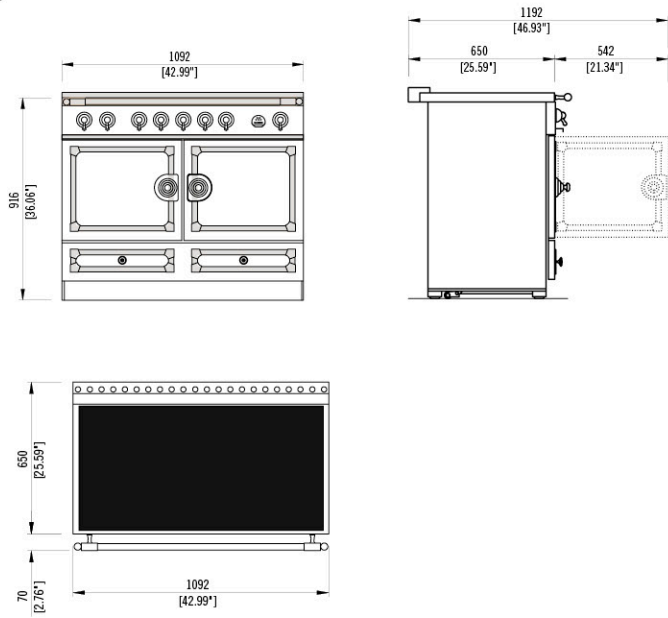

Limited Edition / Designer Series*:

Martyn Lawrence Bullard
 Brands Hatch Green
 Goodwood Blue

Matthew Quinn
 Quintessential Teal (Gloss)
 Quintessential Orange

*Available in two trims ONLY:

Stainless & Brushed Brass
 Stainless & Polished Brass

CORNUFÉ 90 "ALBERTINE": c9

900 W x 650 D x 910 (937 max) H (mm)
 35.4 W x 25.6 D x 35.8 (36.9 max) H (inches)
 315 lb. uncrated, 410 lb. crated
 High-performance 5 burner gas cooktop
 Large electric convection oven
 Classic Color Retail: \$11,525
 Suzanne Kasler Color Collection Retail:\$12,295
 Étoilé Color Retail: \$12,295
 Limited Edition: \$13,265

SPECIFICATIONS:

Gas Burners:

1 17,500 BTU Central Burner
 3 12,000 BTU Burners
 1 6,000 BTU Simmer Burner
 Solid Brass Enamel-Capped Burners with Thermocouple
 Safety Mechanism

Oven:

Enameled steel door with glass inner door
 Electric convection oven featuring 7 cooking modes
 2 Convection Fans, 8 Heating Elements
 714 W x 389 D x 381 H (mm)
 28.1 W x 15.3 D x 15 H (inches)
 3.81 cubic feet
 Range Accessories: Plaque Adaptor Kit, Wok Ring,
 Grill/Griddle Plate, Brass Burners

Power and Fuel:

Voltage: 240v; 60Hz, 16 AMP Breaker
 Gas connection: 1/2 inch NPT at rear left-hand side
 Natural gas range with propane conversion kit included
 High-Altitude Kit required for elevations above 5,000 feet
 Natural Gas High-Altitude Kit "A037977": Retail for \$65
 Propane High-Altitude Kit "A037982": Retail for \$65

Available Finishes:

Classic Colors: Matte Black, Stainless Steel, Gloss Black,
 Provence Blue, and Pure White

Étoilé Colors: Morning Dew, Graphite, Ocean, and Wintersky

Suzanne Kasler
 Colors: Tapestry and Roquefort

Custom Colors
 & Trims: Consult your La Cornue Sales Rep for more information.

Three Trim Options: Stainless Steel Trim and Rail with
 Satin Chrome Accents

Stainless Steel Trim with Polished Brass Rail
 and Accents

Stainless Steel Trim, Polished Stainless Steel Rail, with
 Polished Chrome Accents

NOTE: Side panels are stainless steel for all colors except Gloss Black, Matte Black ranges
 have flat black side panels. The Polished Brass Trim is natural, non-coated metal and will
 patina over time.

For coordinating hoods, please see Page 24.

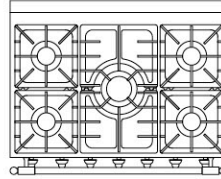
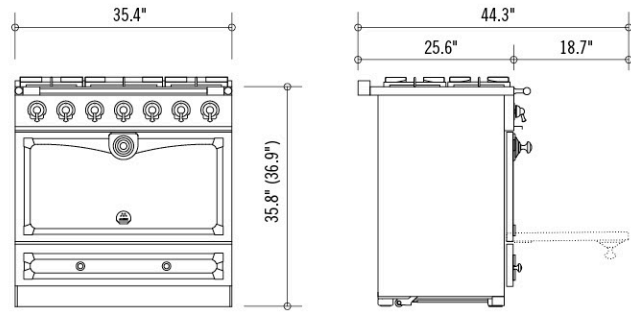

Limited Edition / Designer Series*:

Martyn Lawrence Bullard	Matthew Quinn
Brands Hatch Green	Quintessential Teal (Gloss)
Goodwood Blue	Quintessential Orange

*Available in two trims ONLY:

Stainless & Brushed Brass
 Stainless & Polished Brass

CORNUFÉ 90 “ALBERTINE” INDUCTION: c9-1

900 W x 651 (w/o Handles), 729 (w/ Handles) D x 915 (942 max) H (mm)
 35.4 W x 25.62 (w/o Handles), 28.70 (w/ Handles) D x 36.02 (37.08 max) H (inches)
 315 lb uncrated, 410 lb Crated
 High-performance 5 zone induction cooktop
 Large electric convection oven
 Classic Color Retail: \$12,925
 Suzanne Kasler Color Collection Retail: \$13,775
 Étoilé Color Retail: \$13,775
 Limited Edition: \$14,855

SPECIFICATIONS:

Induction Cooktop ratings:

Front Left: 1.4 kW (Max) 2.2 kW (Boost)

Rear Left: 1.85 kW (Max) 3.0 kW (Boost)

Center: 2.3 kW (Max) 3.7 kW (Boost)

Front Right: 1.85 kW (Max) 3.0 kW (Boost)

Rear Right: 1.85 kW (Max) 3.0 kW (Boost)

Note: Front Right and Rear Right Burners can be bridged

Oven:

Enameled steel door with glass inner door

Electric convection oven featuring 7 cooking modes

2 Convection Fans, 8 Heating Elements

1 Deluxe oven tray

1 Large Tray Equipped with Broil Pan

1 Pastry Tray

2 Telescopic Racks

714 W x 389 D x 381 H (mm)

28.1 W x 15.3 D x 15 H (inches)

3.81 cubic feet

Power and Fuel:

Voltage: 240v; 60Hz, 50 AMP Breaker

Available Finishes:

Classic Colors: Matte Black, Stainless Steel, Gloss Black, Provence Blue, and Pure White

Étoilé Colors: Morning Dew, Graphite, Ocean, and Wintersky

Suzanne Kasler

Colors: Tapestry and Roquefort

Custom Colors: Bespoke

Three Trim Options: Stainless Steel Trim and Rail with Satin Chrome Accents

Stainless Steel Trim with Polished Brass Rail and Accents

Stainless Steel Trim, Polished Stainless Steel Rail, with Polished Chrome Accents

NOTE: Side panels are stainless steel for all colors except Gloss Black, Matte Black ranges have flat black side panels. The Polished Brass Trim is natural, non-coated metal and will patina over time.

For coordinating hoods, please see Page 24.

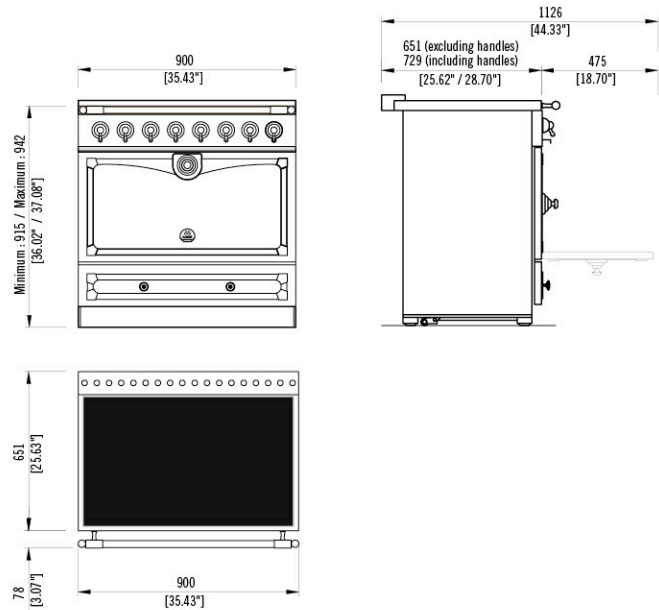

Limited Edition / Designer Series*:

Martyn Lawrence Bullard
 Brands Hatch Green
 Goodwood Blue

Matthew Quinn
 Quintessential Teal (Gloss)
 Quintessential Orange

*Available in two trims ONLY:

Stainless & Brushed Brass
 Stainless & Polished Brass

CORNUFÉ 90 HOOD: H9 (Note: Limited Edition Colors Not Available.)

900 W x 650 D x 700 H (mm)
 35.4 W x 25.6 D x 27.5 H (inches)
 Traditional wall-mounted chimney hood
 Available in all color and trim options
 4-Speed Variable Motor
 One 600 CFM blower – unobstructed air flow with Ø6" duct
 Remote Control and In-Hood Activation Controls
 Three 20W high-intensity lights
 2 dishwasher-safe baffle filters with grease capture system
 Voltage: 120v; 60Hz, total rating: 425W, 3.6 AMP
 Telescopic flue cover extends to maximum hood height of 39.37" (1000 mm)

Classic Color Retail: \$6,505
 Suzanne Kasler Color Collection Retail: \$7,035
 Étoilé Color Retail: \$7,035

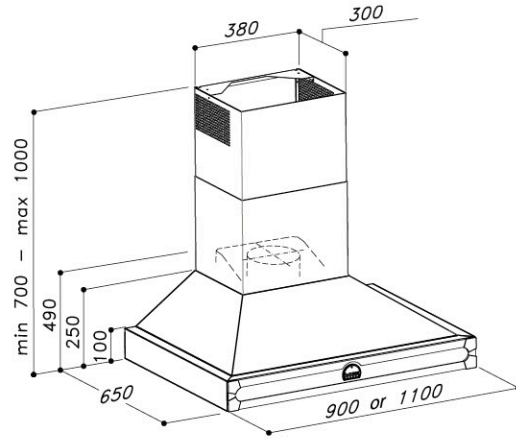

CORNUFÉ 110 HOOD: H1 (Note: Limited Edition Colors Not Available.)

1100 W x 650 D x 700 H (mm)
 43.3 W x 25.6 D x 27.5 H (inches)
 Traditional wall-mounted chimney hood
 Available in all color and trim options
 4-Speed Variable Motor
 One 600 CFM blower – unobstructed air flow with Ø6" duct
 Remote Control and In-Hood Activation Controls
 Three 20W high-intensity Halogen lights
 2 dishwasher-safe baffle filters with grease capture system
 Voltage: 120v; 60Hz, total rating: 425W, 3.6 AMP
 Telescopic flue cover extends to maximum hood height of 39.37" (1000 mm)

Classic Color Retail: \$6,665
 Suzanne Kasler Color Collection Retail: \$7,145
 Étoilé Color Retail: \$7,145

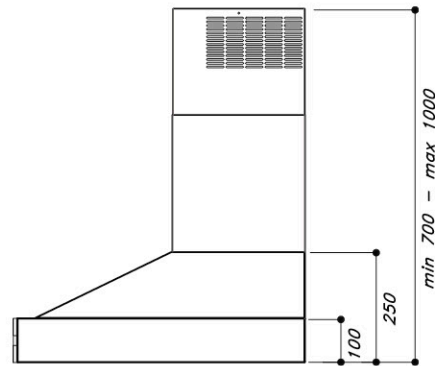

CORNUFÉ HOOD INSERTS

In 2020, La Cornue introduced hood inserts that are available for both ranges in the CornuFé Series. All CornuFé inserts include an internal blower, baffle filters, LED lights, remote control, and 3 speed touch buttons for fan and light control. Please note: The CornuFé inserts are designed for use in custom hoods and are NOT compatible with CornuFé hoods. The CornuFé inserts are inventoried and available for immediate sale.

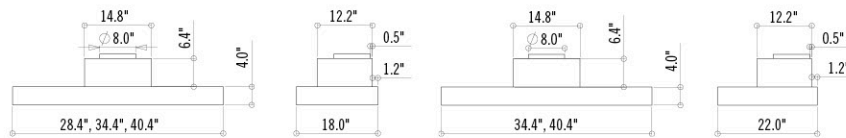

CornuFé Hood Insert: 110LC118

Compatible with C1
 40 3/8" w x 18" d Grade 304 Stainless Steel Hood Insert
 Lights: 2 LED
 Filters: Baffle
 Internal Blower: 600 CFM
 Duct Size: 8"
 Remote Control: Yes
 Approx Weight: 43 lbs
 Retail: \$1,250

CornuFé Hood Insert: 110LC122

Compatible with C1
 40 3/8" w x 22" d Grade 304 Stainless Steel Hood Insert
 Lights: 2 LED
 Filters: Baffle
 Internal Blower: 600 CFM
 Duct Size: 8"
 Remote Control: Yes
 Approx Weight: 49 lbs
 Retail: \$1,500

CornuFé Hood Insert: 90LC118

Compatible with C9
 34 3/8" w x 18" d Grade 304 Stainless Steel Hood Insert
 Lights: 2 LED
 Filters: Baffle
 Internal Blower: 600 CFM
 Duct Size: 8"
 Remote Control: Yes
 Approx Weight: 40 lbs
 Retail: \$1,200

CornuFé Hood Insert: 90LC122

Compatible with C9
 34 3/8" w x 22" d Grade 304 Stainless Steel Hood Insert
 Lights: 2 LED
 Filters: Baffle
 Internal Blower: 600 CFM
 Duct Size: 8"
 Remote Control: Yes
 Approx Weight: 46 lbs
 Retail: \$1,450

CORNUFÉ CASCADE : CH3630CAC & CH4430CAC

Hood Style: Concave
Available in both 36" & 44"
36"W x 24"D x 30"H (390 or 600 cfm/8" collar)
44"W x 24"D x 30"H (390 or 600 cfm/8" collar and 1200 cfm/10")

Duct Cover Options:
12", 24" and 48" Tall
Custom Duct Cover heights are available

Product Weight:
36"(30"H) : 97 lbs
44"(30"H) : 124 lbs

Electrical Requirements:
600 CFM models draw approx. 2.7 Amps
1200 CFM models draw approx. 5.4 Amps
Voltage: 120v; 60Hz; 15amps

Hood Sone Level:
Ranges from 5-7

CORNUFÉ CASCADE 36"
Classic Color Retail: Starting from \$7,739
Suzanne Kasler Color Collection Retail: Starting from \$8,149
Étoilé Color Retail: Starting from \$8,149
Trims available: Satin Chrome, Polished Chrome, Polished Brass

CORNUFÉ CASCADE 44"
Classic Color Retail: Starting from \$8,149
Suzanne Kasler Color Collection Retail: Starting from \$8,589
Étoilé Color Retail: Starting from \$8,589
Trims available: Satin Chrome, Polished Chrome, Polished Brass

Available in Limited Edition Colors and Trims - pricing varies - refer to price sheet

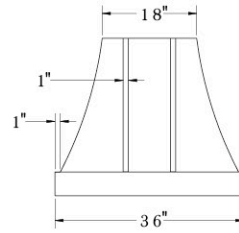

FRONT VIEW

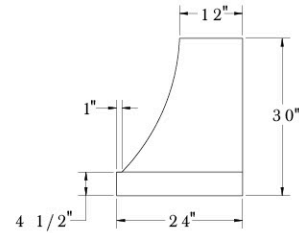

SIDE VIEW

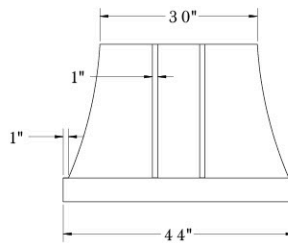

FRONT VIEW

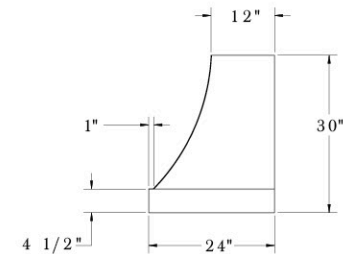

SIDE VIEW

CORNUFÉ EUCLID : CH3630EUC & CH4430EUC

Hood Style: Trapezoid

Available in both 36" & 44"
36"W x 24"D x 30"H (600 cfm/8" collar)
44"W x 24"D x 30"H (1200 cfm/10" collar)

Duct Cover Options:
12", 24" and 48" Tall
Custom Duct Cover heights are available

Product Weight: 36"(30"H) : 98 lbs/ 44"(30"H) : 126 lbs

Electrical Requirements:
600 CFM models draw approx. 2.7 Amps
1200 CFM models draw approx. 5.4 Amps
Voltage: 120v; 60Hz; 15amps

Hood Sone Level:
Ranges from 5-7

CORNUFÉ EUCLID 36"
Classic Color Retail: Starting from \$7,469
Suzanne Kasler Color Collection Retail: Starting from \$7,869
Étoilé Color Retail: Starting from \$7,869
Trims available: Satin Chrome, Polished Chrome, Polished Brass

CORNUFÉ EUCLID 44"
Classic Color Retail: Starting from \$7,699
Suzanne Kasler Color Collection Retail: Starting from \$8,119
Étoilé Color Retail: Starting from \$8,119
Trims available: Satin Chrome, Polished Chrome, Polished Brass

Available in Limited Edition Colors and Trims - pricing varies - refer to price sheet

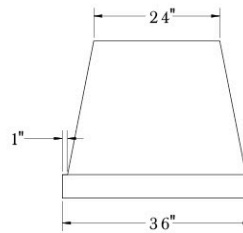

FRONT VIEW

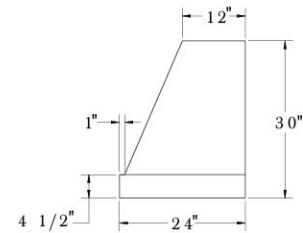

SIDE VIEW

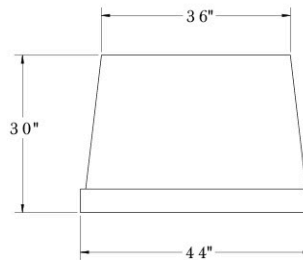

FRONT VIEW

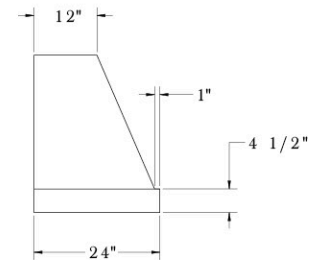

SIDE VIEW

CORNUFÉ LOGE : CH3630LGE & CH4430LGE

Hood Style: Box

Available in both 36" & 44"

36"W x 24"D x 30"H, 42"H or 54"H (600 cfm/8" collar)

44"W x 24"D x 30"H, 42"H or 54"H (1200 cfm/10" collar)

Product Weight:

36"(30"H) : 104 lbs / 36"(42"H) : 122 lbs / 36"(54"H) : 141 lbs

44"(30"H) : 130 lbs / 44"(42"H) : 151 lbs / 44"(54"H) : 172 lbs

Electrical Requirements:

600 CFM models draw approx. 2.7 Amps

1200 CFM models draw approx. 5.4 Amps

Voltage: 120v; 60Hz; 15amps

Hood Sone Level:

Ranges from 5-7

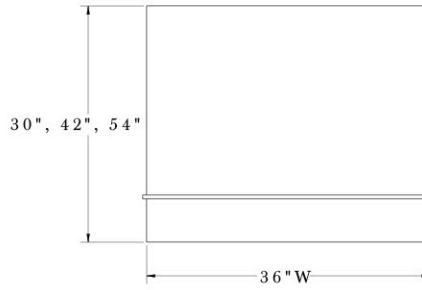

FRONT VIEW

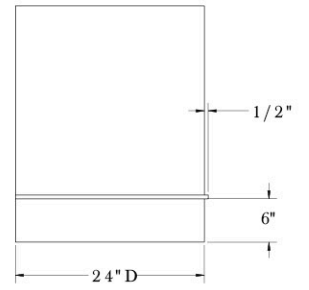

SIDE VIEW

CORNUFÉ LOGE 36"

Classic Color Retail: Starting from \$7,119

Suzanne Kasler Color Collection Retail: Starting from \$7,499

Étoilé Color Retail: Starting from \$7,499

Trims available: *Satin Chrome, Polished Chrome, Polished Brass*

CORNUFÉ LOGE 44"

Classic Color Retail: Starting from \$7,319

Suzanne Kasler Color Collection Retail: Starting from \$7,719

Étoilé Color Retail: Starting from \$7,719

Trims available: *Satin Chrome, Polished Chrome, Polished Brass*

Available in Limited Edition Colors and Trims - pricing varies - refer to price sheet

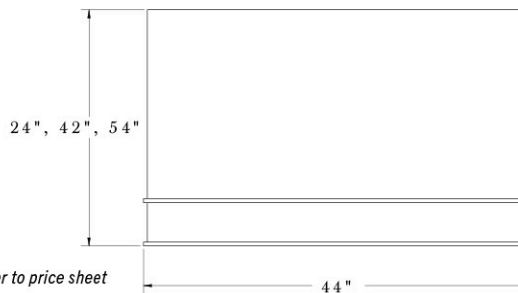

FRONT VIEW

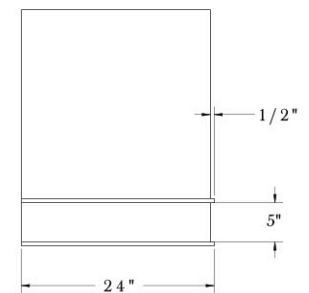

SIDE VIEW

CORNUFÉ MARQUEE : CH3630MRQ & CH4430MRQ

Hood Style: Arched Front

Available in both 36" & 44"

36"W x 24"D x 30"H (600 cfm/8" collar)

44"W x 24"D x 30"H (1200 cfm/10" collar)

Duct Cover Options:

12", 24" and 48" Tall

Custom Duct Cover heights are available

Product Weight: 36"(30"H) : 101 lbs / 44"(30"H) : 126 lbs

Electrical Requirements:

600 CFM models draw approx. 2.7 Amps

1200 CFM models draw approx. 5.4 Amps

Voltage: 120v; 60Hz; 15amps

Hood Sone Level:

Ranges from 5-7

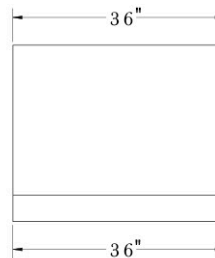

FRONT VIEW

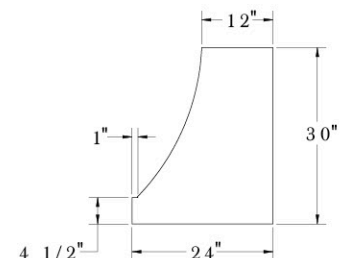

SIDE VIEW

CORNUFÉ MARQUEE 36"

Classic Color Retail: Starting from \$7,399

Suzanne Kasler Color Collection Retail: Starting from \$7,799

Étoilé Color Retail: Starting from \$7,799

Trims available: *Satin Chrome, Polished Chrome, Polished Brass*

CORNUFÉ MARQUEE 44"

Classic Color Retail: Starting from \$7,609

Suzanne Kasler Color Collection Retail: Starting from \$8,019

Étoilé Color Retail: Starting from \$8,019

Trims available: *Satin Chrome, Polished Chrome, Polished Brass*

Available in Limited Edition Colors and Trims - pricing varies - refer to price sheet

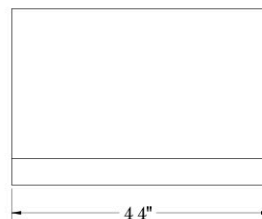

FRONT VIEW

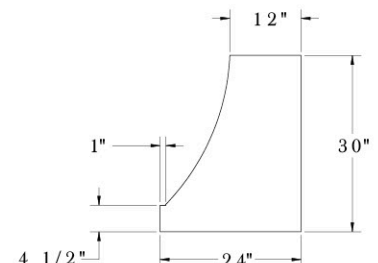

SIDE VIEW

CornuFé Series Details & Accessories

CLASSIC COLORS

N	Matte Black
M	Gloss Black
I	Stainless Steel
W	Pure White
L	Provence Blue

ÉTOILÉ COLORS

P	Morning Dew
G	Graphite
O	Ocean
H	Wintersky

SUZANNE KASLER COLOR COLLECTION

A	Tapestry
Q	Roquefort

LIMITED EDITION COLORS / DESIGNER SERIES MARTYN LAWRENCE BULLARD

MQT	Quintessential Teal (Gloss)
MQO	Quintessential Orange
MLG	Brands Hatch Green
MLB	Goodwood Blue

Limited Edition Trim Options

B	Stainless Steel Polished Brass Polished Brass
L	Stainless Steel Brushed Brass Brushed Brass

TRIM OPTIONS

	Trim	Accents	Rails
N	Stainless Steel	Satin Chrome	Stainless Steel
F	Stainless Steel	Polished Brass	Polished Brass
P	Stainless Steel	Polished Chrome	Polished Stainless Steel

Note: The Polished Brass Trim is natural, non coated metal and will patina over time.

ACCESSORIES (AVAILABLE FOR 110 AND 90):

Model Number	Description	Price
CFEBPLATE	French Plaque for CornuFé 110 Dual Fuel Ranges	\$1,655
CFEBPLATE90	French Plaque for CornuFé 90 Dual Fuel Ranges	\$1,655
CFEGRIDDLE	Grill/Griddle Plate for all CornuFé Dual Fuel Ranges	\$825
P050553	Wok Adapter for all CornuFé Dual Fuel Ranges	\$245
A037977	High Altitude Kit - Natural Gas for all CornuFé Dual Fuel Ranges	\$65
A037982	High Altitude Kit - Propane for all CornuFé Dual Fuel Ranges	\$65
09KIRSIR01	Recirculating kit for CornuFé Hood	\$485
P030292	CornuFé 110 Extra Flat Rack	\$105
CFDF5BB	CornuFé Dual Fuel 5 Brass Burner Accessory Kit	\$775

Please confirm inventory status at time of order.

Rôtisserie

The Flamberge Rôtisserie is a wall-mounted gas rôtisserie designed for residential use. Constructed with a concave rear wall of solid cast iron, it is heated by a powerful gas burner set beneath three motorized spits. Synthetic wicks pull the heat up through the vaulted back of the unit, allowing the radiant heat to gently cook foods as they rotate slowly on a spit over the flame.

FLAMBERGE RÔTISSERIE: BFG

Unit Dimensions: 755 W x 380 D x 725 H (mm)
29.7 W x 15 D x 28.5 H (inches)

Minimum Cutout Dimensions: 760 W x 457 D x 730 H (mm)
30 W x 18 D x 28.7 H (inches)

Dimensions of Metal Trim Frame: 815 W x 792 H (mm)
32 W x 31.2 H (inches)

Crated Weight: 330 lbs; Uncrated Weight: 132 lbs

Voltage: 120v, 10 AMP Breaker

Available in gas only (Natural or Propane)

Gas – 27,000 BTU Natural or 25,000 BTU Propane

Accessories Included:

2 Metal Spits

1 Fish Basket

1 Porcelain Enamel Drip Tray

Starting from \$19,100

Please note: The Centenary Rôtisserie is a UL-Approved product for residential installation. This is a zero clearance product. Ventilation is not required, but may be used as desired.

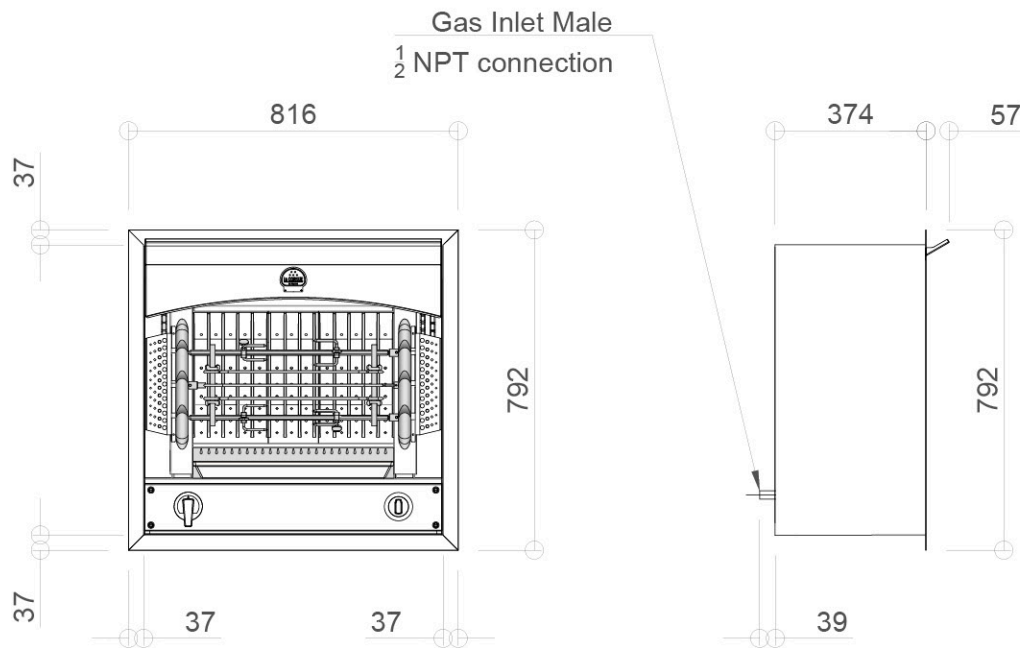

La Cornue Accessories & Options

La Cornue offers a variety of accessories to complement our ranges, as well as some options for items which complement the La Cornue cooking experience. Alternative finishes are also available for specific design aesthetics.

POTRACKS: POT

2 solid metal brackets and 1 metal potrack bar, equipped with 5 solid metal hooks. 1800 mm length is supplied with 3 brackets and 8 hooks. Wall-mounted. Additional metal hooks available with purchase. Pots are not included.

Length (mm)	(inches)	Brushed or Polished Brass	Brushed Nickel, Polished Chrome, Black Shiny Chrome or Matte Black	Brushed or Polished Copper or Matte Bronze
750	29.5	\$4,200	\$4,800	\$5,400
900	35.4	\$4,500	\$5,200	\$5,900
1200	47.2	\$5,100	\$5,800	\$6,600
1500	59.1	\$5,800	\$6,700	\$7,600
1650	65.0	\$5,900	\$6,800	\$7,700
1800	70.9	\$6,300	\$7,200	\$8,200

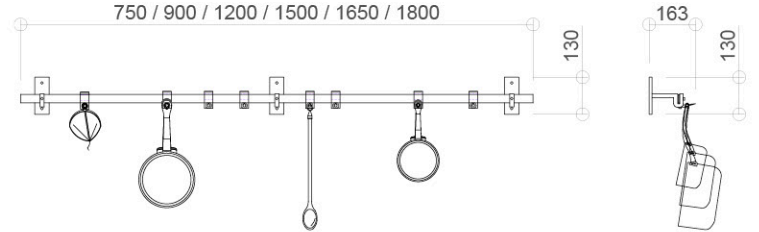

RATELIER: RAT

Solid Dark Walnut or Light Oak shelf nests atop 2 black cast aluminum brackets, which serve as support for solid metal potrack bar with 5 solid metal hooks. Wall-mounted. Additional metal hooks available with purchase. Pots are not included.

Length (mm)	(inches)	Brushed or Polished Brass	Brushed Nickel, Polished Chrome, Black Shiny Chrome or Matte Black	Brushed or Polished Copper or Matte Bronze
800/900/1000	31.5/35.4/39.4	\$6,300	\$7,200	\$8,200
1200	47.2	\$7,200	\$8,200	\$9,300
1400	55.1	\$7,800	\$9,000	\$10,200

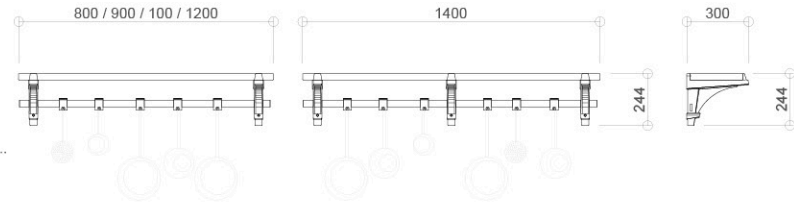

ETAGER: ETA

Solid Dark Walnut or Light Oak shelf nests atop 2 black cast aluminum brackets. Wall-mounted.

Length (mm)	(inches)	Price
800 / 900 / 1000	31.5 / 35.4 / 39.4	\$3,200
1200	47.2	\$3,400
1400	55.1	\$3,700

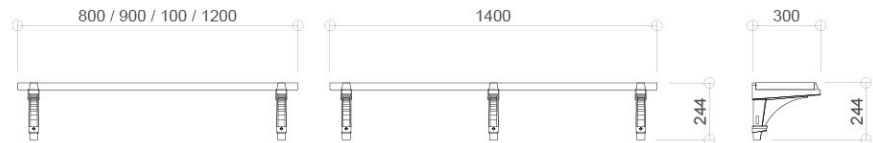

New Cuisine de Château Cabinetry by La Cornue. Refined for Modern Living.

La Cornue proudly presents the next evolution of Cuisine de Château Cabinetry — where classic craftsmanship meets modern elegance. Thoughtfully redesigned, our cabinetry features streamlined lines and refined proportions while honoring the timeless codes of our Château heritage.

- **Enhanced Precision:** Reduced gaps between drawers and cooktop for a sleeker, more tailored look. Perfect alignment of drawers, doors, and cleanliness handles delivers impeccable symmetry.
- **Seamless Integration:** Optional Stainless Steel countertops and extended cooktops (up to 2800mm) create a continuous, professional finish. Extend the signature towel rail — even with marble, stone, or other materials — for a cohesive design. Speak with your La Cornue Sales Representative for details and pricing.
- **Customizable Finishes:** Cabinet sides come unfinished; for exposed ends, specify a finished end panel (EME), with or without decorative frames. Add electrical outlets to end panels — ideal for island configurations (upcharges apply).
- **Complete your kitchen's seamless aesthetic** with custom panels designed for undercounter refrigeration and ice machines from leading manufacturers such as U-Line and Sub-Zero. Please note certain models may require review, and weight considerations will be factored into the design.

Create a truly bespoke kitchen — build your entire space with Cuisine de Château Cabinetry. CAD files are available online, and our CAD specialists are ready to assist.

TIROIR CASSEROLIER COUVERTS 500 TCC50

500 W x 665 D x 885 H (mm)
 19.7 W x 26.2 D x 34.8 H (inches)
 2 Small Drawers
 1 Large Drawer
 Solid Oak or Walnut drawer bottom
 Starting from \$13,900
 Optional Interior Drawer Slide Out – TAA50 - \$2,100

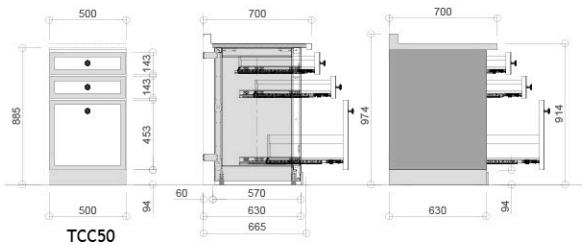

TIROIR CASSEROLIER COUVERTS 600 TCC60

600 W x 665 D x 885 H (mm)
 23.6 W x 26.2 D x 34.8 H (inches)
 2 Small Drawers
 1 Large Drawer
 Solid Oak or Walnut drawer bottom
 Starting from \$14,200
 Optional Interior Drawer Slide Out – TAA60 - \$2,200

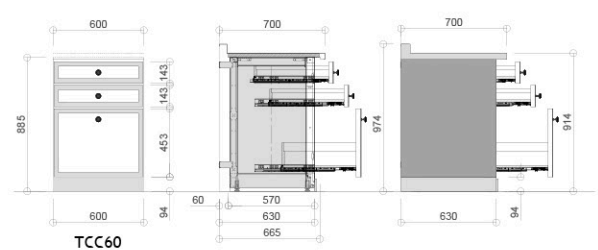

TIROIR CASSEROLIER COUVERTS 800 TCC80

800 W x 665 D x 885 H (mm)
 31.5 W x 26.2 D x 34.8 H (inches)
 2 Small Drawers
 1 Large Drawer
 Solid Oak or Walnut drawer bottom
 Starting from \$14,700
 Optional Interior Drawer Slide Out – TAA80 - \$2,300

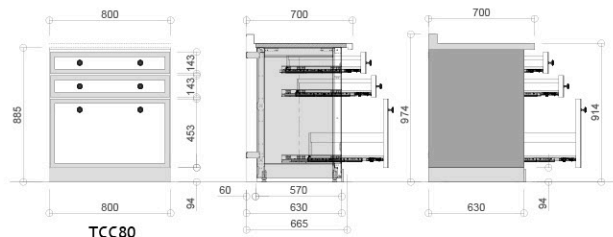

TIROIR CASSEROLIER VAISSELLIER 500 TCV50

500 W x 665 D x 885 H (mm)
 19.7 W x 26.2 D x 34.8 H (inches)
 1 Small Drawer
 2 Large Drawers
 Solid Oak or Walnut drawer bottom
 Starting from \$15,300

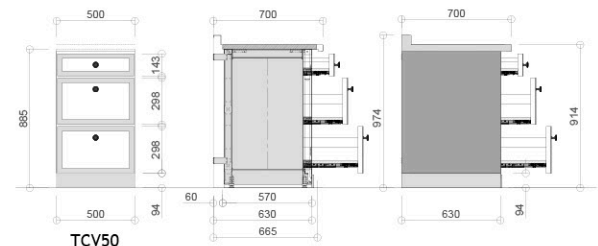

TIROIR CASSEROLIER VAISSELLIER 600 TCV60

600 W x 665 D x 885 H (mm)
 23.6 W x 26.2 D x 34.8 H (inches)
 1 Small Drawer
 2 Large Drawers
 Solid Oak or Walnut drawer bottom
 Starting from \$16,600

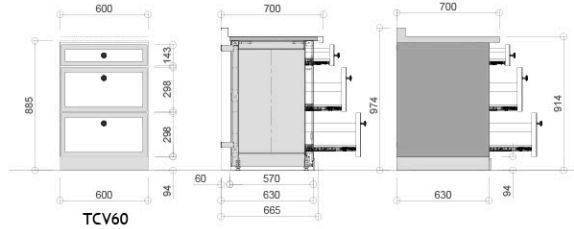

TIROIR CASSEROLIER VAISSELLIER 800 TCV80

800 W x 665 D x 885 H (mm)
 31.5 W x 26.2 D x 34.8 H (inches)
 1 Small Drawer
 2 Large Drawers
 Solid Oak or Walnut drawer bottom
 Starting from \$18,000

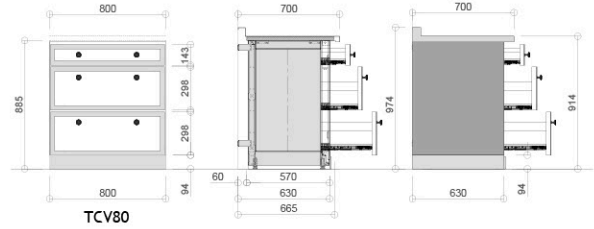

TIROIR CASSEROLIER MARMITES 500 TCM50

500 W x 665 D x 885 H (mm)
 19.7 W x 26.2 D x 34.8 H (inches)
 1 Medium Drawer
 1 Large Drawer
 Solid Oak or Walnut drawer bottom
 Starting from \$13,100
 Optional Interior Drawer Slide Out – TAA50 - \$2,100

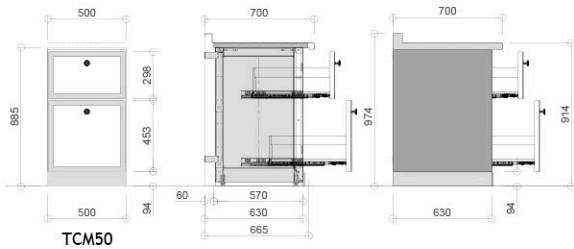

TIROIR CASSEROLIER MARMITES 600 TCM60

600 W x 665 D x 885 H (mm)
 23.6 W x 26.2 D x 34.8 H (inches)
 1 Medium Drawer
 1 Large Drawer
 Solid Oak or Walnut drawer bottom
 Starting from \$13,400
 Optional Interior Drawer Slide Out – TAA60 - \$2,200

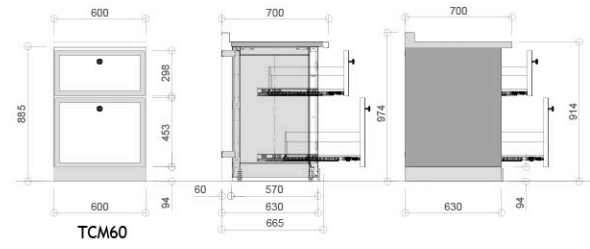

TIROIR CASSEROLIER MARMITES 800 TCM80

800 W x 665 D x 885 H (mm)
 31.5 W x 26.2 D x 34.8 H (inches)
 1 Medium Drawer
 1 Large Drawer
 Solid Oak or Walnut drawer bottom
 Starting from \$14,000
 Optional Interior Drawer Slide Out – TAA80 - \$2,300

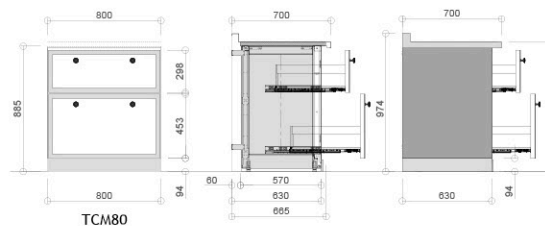

OPTIONAL INTERIOR "ENGLISH DRAWER" DRAWER SLIDE OUT

Compatible with TCM50,
 TCM60, TCM80, TCC50,
 TCC60, TCC80

PORTE SIMPLE 500 TECHNIQUE PST50

500 W x 665 D x 885 H (mm)
 19.7 W x 26.2 D x 34.8 H (inches)
 1 Functional Drawer
 1 Door, Left- or Right-hand Hinged
 Supplied with a shelf and base in solid Oak or Walnut
 Stainless Steel inner sides and back
 Starting from \$13,400

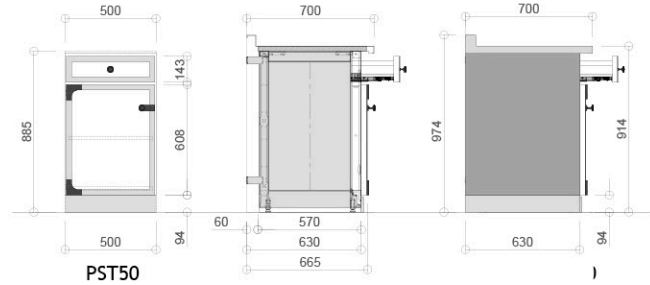

PORTE SIMPLE TECHNIQUE 600 PST60

600 W x 665 D x 885 H (mm)
 23.6 W x 26.2 D x 34.8 H (inches)
 1 Functional Drawer
 1 Door, Left- or Right-hand Hinged
 Supplied with a shelf and base in solid Oak or Walnut
 Stainless Steel inner sides and back
 Starting from \$13,800

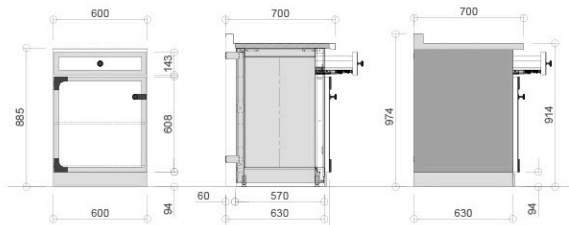

PORTE DOUBLE TECHNIQUE 900 PDT09

Porte Double Technique 900 PDT90
 900 W x 665 D x 885 H (mm)
 35.4 W x 26.2 D x 34.8 H (inches)
 2 Functional Drawers
 2 doors
 Supplied with a shelf and base in solid Oak or Walnut
 Stainless Steel inner sides and back
 Starting from \$21,200

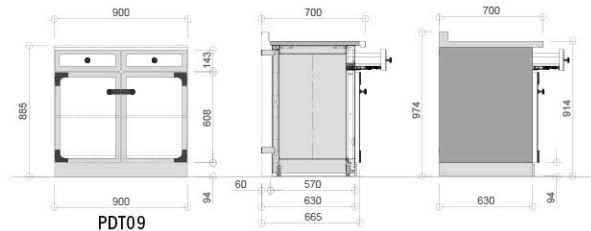

PORTE DOUBLE TECHNIQUE 1000 PDT10

1000 W x 665 D x 885 H (mm)
 39.4 W x 26.2 D x 34.8 H (inches)
 2 Functional Drawers
 2 doors
 Supplied with a shelf and base in solid Oak or Walnut
 Stainless Steel inner sides and back
 Starting from \$21,800

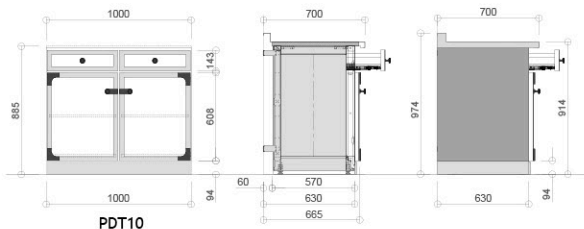

PORTE DOUBLE TECHNIQUE 1200 PDT12

1200 W x 665 D x 885 H (mm)
 47.2 W x 26.2 D x 34.8 H (inches)
 2 Functional Drawers
 2 doors
 Supplied with a shelf and base in solid Oak or Walnut
 Stainless Steel inner sides and back
 Starting from \$23,000

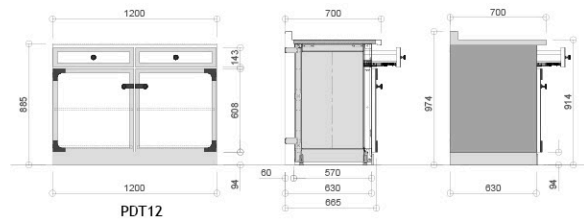

Drawers can be configured as non-operational to seamlessly integrate sinks. Cabinet backs and floors can also be customized to accommodate plumbing requirements. Upcharge applies.

PORTE SIMPLE MAXI 400 PSM40

400 W x 665 D x 885 H (mm)
15.7 W x 26.2 D x 34.8 H (inches)
1 Door, Left- or Right-hand Hinged
Supplied with a shelf and base in solid Oak or Walnut
Stainless Steel inner sides and back
Starting from \$12,200

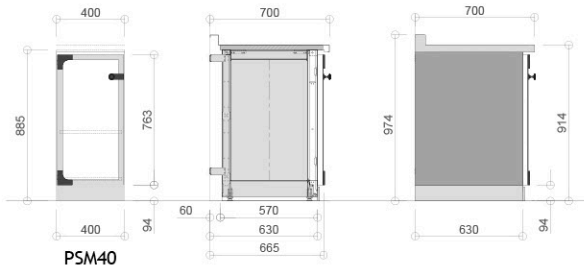

PORTE SIMPLE MAXI 500 PSM50

500 W x 665 D x 885 H (mm)
19.7 W x 26.2 D x 34.8 H (inches)
1 Door, Left- or Right-hand Hinged
Supplied with a shelf and base in solid Oak or Walnut
Stainless Steel inner sides and back
Starting from \$12,300

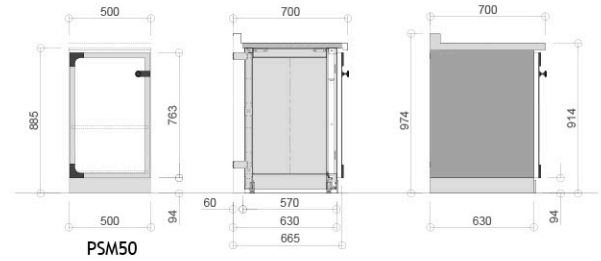

PORTE SIMPLE MAXI 550 PSM55

550 W x 665 D x 885 H (mm)
21.7 W x 26.2 D x 34.8 H (inches)
1 Door, Left- or Right-hand Hinged
Supplied with a shelf and base in solid Oak or Walnut
Stainless Steel inner sides and back
Starting from \$12,800

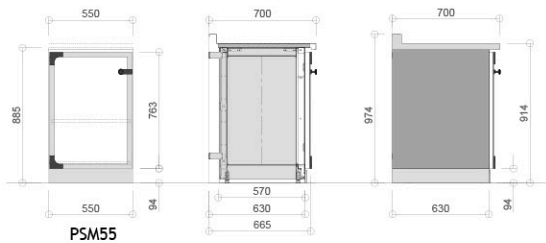

PORTE SIMPLE MAXI 600 PSM60

600 W x 665 D x 885 H (mm)
23.6 W x 26.2 D x 34.8 H (inches)
1 Door, Left- or Right-hand Hinged
Supplied with a shelf and base in solid Oak or Walnut
Stainless Steel inner sides and back
Starting from \$13,100

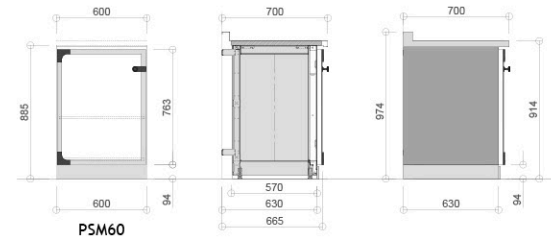

PORTE SIMPLE MAXI 700 PSM70

700 W x 665 D x 885 H (mm)
27.6 W x 26.2 D x 34.8 H (inches)
1 Door, Left- or Right-hand Hinged
Supplied with a shelf and base in solid Oak or Walnut
Stainless Steel inner sides and back
Starting from \$13,800

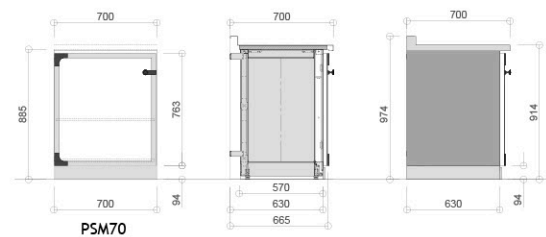

PORTE DOUBLE MAXI 900 PDM09

900 W x 665 D x 885 H (mm)
35.4 W x 26.2 D x 34.8 H (inches)
2 doors
Supplied with a shelf and base in solid Oak or Walnut
Stainless Steel inner sides and back
Starting from \$19,800

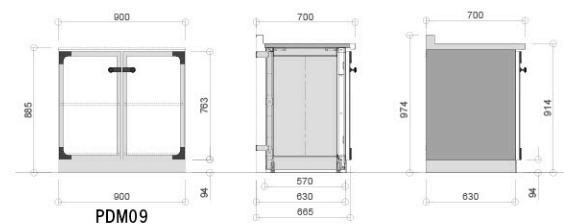

Drawers can be configured as non-operational to seamlessly integrate sinks. Cabinet backs and floors can also be customized to accommodate plumbing requirements. Upcharge applies.

PORTE DOUBLE MAXI 1000 PDM10

1000W x 665 D x 885 H (mm)
 39.4 W x 26.2 D x 34.8 H (inches)
 2 doors
 Supplied with a shelf and base *shelf is not adjustable*
 Stainless Steel inner sides and back in solid Oak or Walnut
 Starting from \$20,400

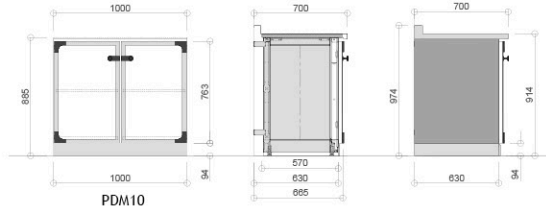

PORTE DOUBLE MAXI 1200 PDM12

1200W x 665 D x 885 H (mm)
 47.2 W x 26.2 D x 34.8 H (inches)
 2 doors
 Supplied with a shelf and base in solid Oak or Walnut
 Stainless Steel inner sides and back
 Starting from \$23,000

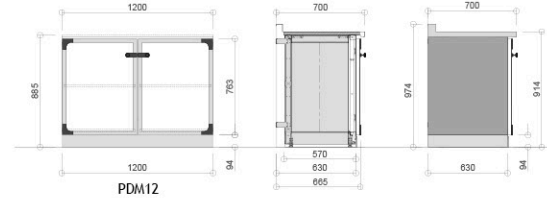

POUBELLE TIROIR 500 (WASTE BIN) WITH TOP DRAWER AND DISPOSAL PBT50

500 W x 665 D x 885 H (mm)
 19.7 W x 26.2 D x 34.8 H (inches)
 1 Small Drawer (Solid Oak or Walnut drawer bottom)
 1 Large Drawer
 Two 19L Waste Bins Included
 Starting from \$13,800

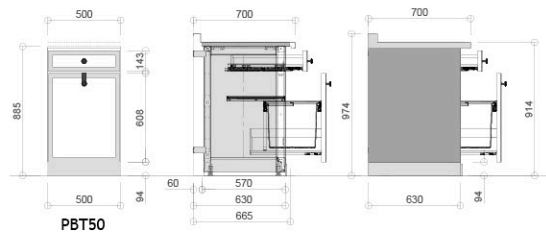
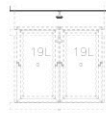

POUBELLE TIROIR 600 (WASTE BIN) WITH TOP DRAWER AND DISPOSAL PBT60

600 W x 665 D x 885 H (mm)
 23.6 W x 26.2 D x 34.8 H (inches)
 1 Small Drawer (Solid Oak or Walnut drawer bottom)
 1 Large Drawer
 One 30L + Two 8L Waste Bins Included
 Starting from \$14,100

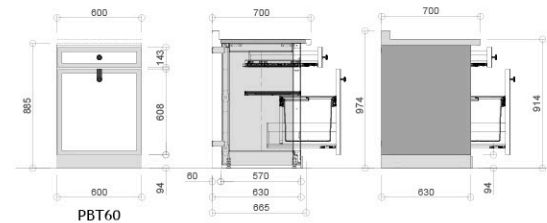
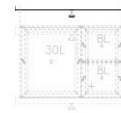

POUBELLE TIROIR 800 (WASTE BIN) WITH TOP DRAWER AND DISPOSAL PBT80

800 W x 665 D x 885 H (mm)
 31.5 W x 26.2 D x 34.8 H (inches)
 1 Small Drawer (Solid Oak or Walnut drawer bottom)
 1 Large Drawer
 One 30L + One 19L + One 16L Waste Bins Included
 Starting from \$15,000

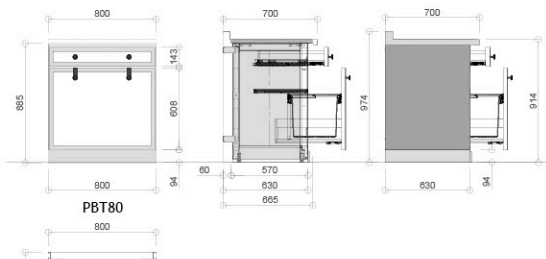
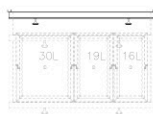

DISHWASHER FACADE 610 HLV

610 W x 885 H (mm)
 24 W x 34.8 H (inches)
 Single panel mounted to front of dishwasher
 Compatible with Gaggeneau G1976760 or Viking VKFDWU524
 *Other Dishwasher Models may be compatible / Consult your La Cornue Sales Rep
 Must be installed between cabinets
 Panel comprised of enameled steel façade with frame and knob, Stainless Steel plinth (replaces original) and adaptor for attachment to countertop
 Panel weight: 19.8 lbs (9kg)
 Starting from \$6,900

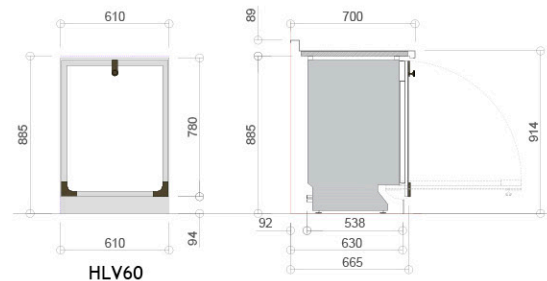

Drawers can be configured as non-operational to seamlessly integrate sinks. Cabinet backs and floors can also be customized to accommodate plumbing requirements. Upcharge applies.

EPICERIE 250 - EPICE

250 W x 665 D x 885 H (mm)
 9.8 W x 26.2 D x 34.8 H (inches)
 1st Drawer - Oak or Walnut bottom
 2nd Drawer - three removable containers with lids and a Oak or Walnut bottom
 3rd Drawer - two removable containers with lids and a Oak or Walnut bottom
 4th Drawer - Oak or Walnut bottom
 Walnut starting from \$16,400
 Oak starting from \$13,200

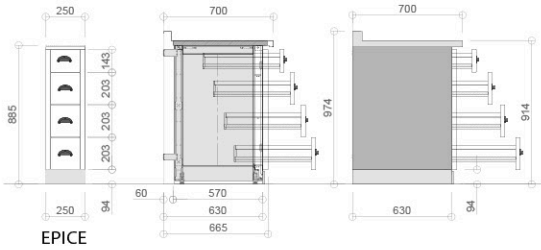

EPICERIE HUILERIE 25 - SAUCE

250 W x 665 D x 885 H (mm)
 9.8 W x 26.2 D x 34.8 H (inches)
 "Spice and Oil Cabinet"
 1st Drawer - Oak or Walnut bottom
 2nd Drawer - three removable containers with lids and a Oak or Walnut bottom
 3rd Drawer - Oak or Walnut bottom for tall bottles and oils
 Walnut starting from \$15,000
 Oak starting from \$12,500

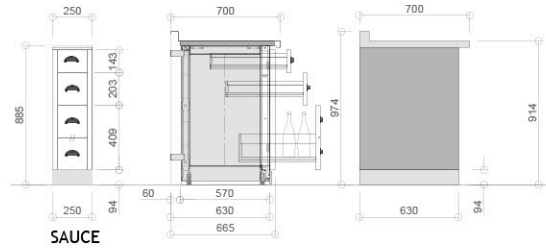

POTAGE 500 - POTAG

500 W x 630 D x 885 H (mm)
 19.7 W x 24.8 D x 34.8 H (inches)
 3 Shelves
 1 tray & 2 baskets
 Walnut starting from \$15,500
 Oak starting from \$14,700

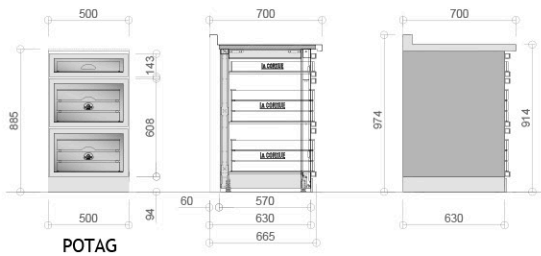

BUTCHER BLOCK: TAG

700 W x 615 D x 830 H (mm)
 27.6 W x 24.2 D x 32.7 H (inches)
 Solid Oak Butcher Block with Beech Top Board
 1 Drawer
 Knife Rack
 Available Trims: A, D, B, L, C, N, V and K (see page 14)
 Walnut Stain starting from \$14,200
 Standard Oak starting from \$12,900

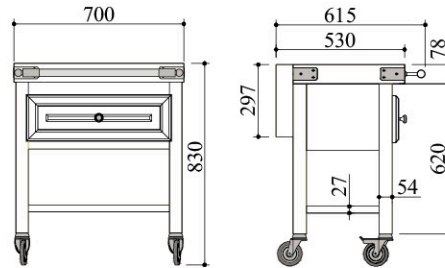

Special Cooktop Cabinetry

The Special Cooktop Cabinetry line is designed for additional cooktop elements, such as a Gaggenau In-Counter Steamer or Deep Fryer.

PORTE SIMPLE ABAISSÉE 450 (LOWERED) PSA45

450 W x 665 D x 714 H (mm)
 17.7 W x 26.2 D x 28 H (inches)
 1 Door, Left- or Right-hand Hinged
 Supplied with a shelf and base in solid Oak or Walnut
 Stainless Steel inner sides and back
 Starting from \$12,200

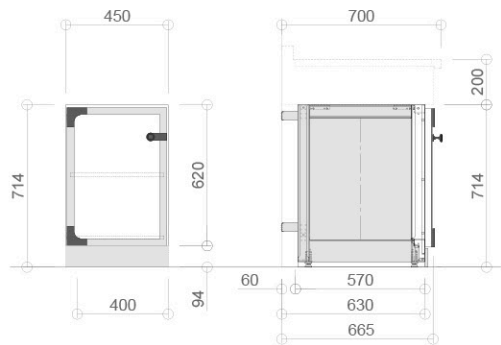

PORTE DOUBLE ABAISSÉE (LOWERED) PDA90

900 W x 665 D x 714 H (mm)
 35.4 W x 26.2 D x 28 H (inches)
 1 Door, Left- or Right-hand Hinged
 Supplied with a shelf and base in solid Oak or Walnut
 Stainless Steel inner sides and back
 Starting from \$13,900

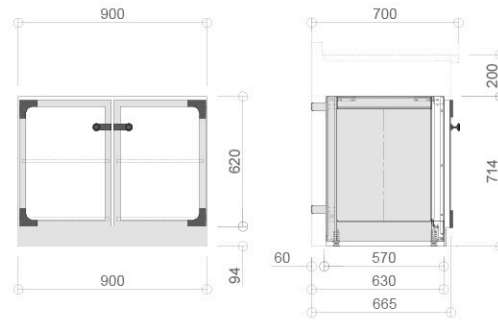

SPECIAL COOKTOP ONLY WITH STAINLESS STEEL TOP 450: DN4

450 W x 700 D x 260 H (mm)
 17.7 W x 27.6 D x 10.2 H (inches)
 Cooktop Only Cabinetry with Stainless Steel Top
 Often used adjacent to Château rangetops
 Starting from \$5,900

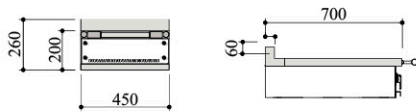

Corner & Filler Cabinetry

CORNER CABINET 'LEMANS' DOOR 600 WITH SHELVES - PAE60

Dimensions vary with filler panel
 Corner cabinetry, designed specifically to allow for storage in lost corners.
 Fixed Shelving, without stainless steel sides
 Starting from \$23,300

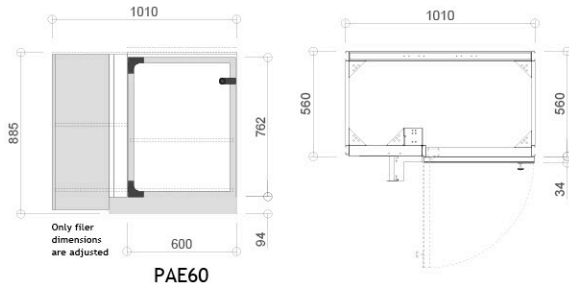

CORNER CABINET 'LEMANS' DOOR 600 WITH ROTATING SHELVING - PLM60

Dimensions vary with filler panel
 Corner cabinetry, designed specifically to allow for storage in lost corners.
 Rotating Shelving, without stainless steel sides
 Starting from \$25,200

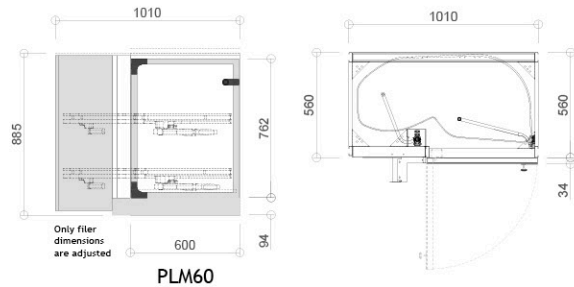

STRAIGHT FILLER: FID

(<200mm) - Starting from \$800

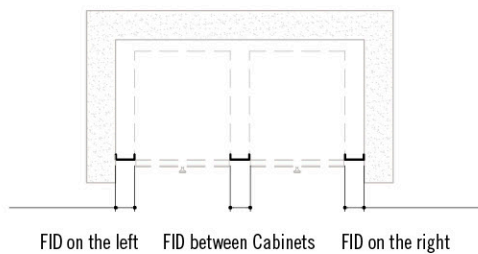

CORNER FILLER: FIA

(<200mm) - Starting from \$1,200

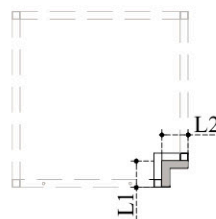

Optional Finished Sides and Exterior Back

- 0 - Enameled side without frame: Standard Color from: \$1,300
- A - 1 false frame on the side or the back: Standard Color and Trim from: \$4,100
- B - 2 false frames on the side or the back: Standard Color and Trim from: \$4,800
- C - 2 false frames on the side or the back: Standard Color and Trim from: \$4,800

0 - Enameled side without frame

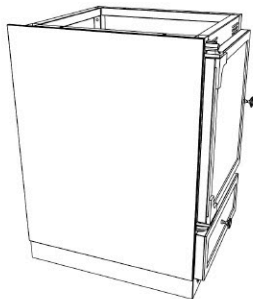

A - 1 false frame on the side or the back

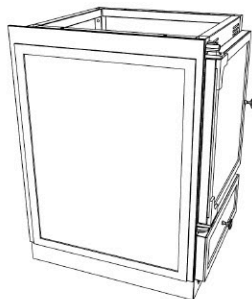

B - 2 false frames on the side or the back

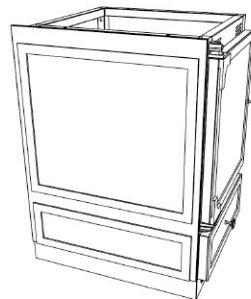

C - 2 false frames on the side or the back

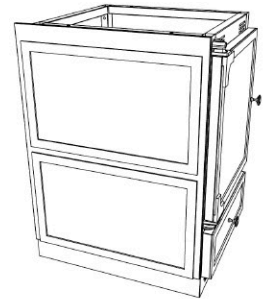

PLEASE NOTE: Panels with trim are 19 mm wide (0.75 inches) and panels without trim are 15 mm wide (0.60 inches)

Cabinet Drawer Inserts & Accessories



CUTLERY DRAWER INSERTS

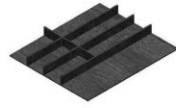

500 mm
OAK \$220.00
SKU: 03RCV-500CHN
WALNUT \$305.00
SKU: 03RCV-500NYR

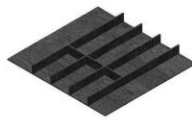

600 mm
OAK \$305.00
SKU: 03RCV-600CHN
WALNUT \$330.00
SKU: 03RCV-600NYR

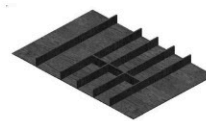

800 mm
OAK \$330.00
SKU: 03RCV-800CHN
WALNUT \$415.00
SKU: 03RCV-800NYR

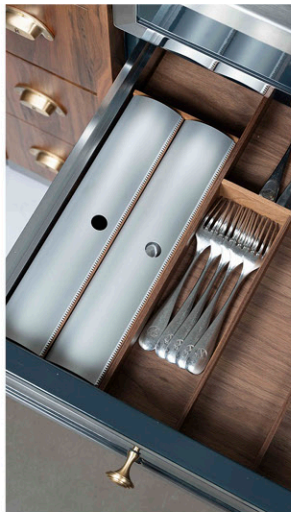

INDEPENDENT DRAWER ORGANIZERS

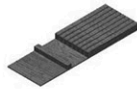

Knife Holder
OAK \$330.00
SKU: 03BTC-000CHN
WALNUT \$415.00
SKU: 03BTC-000NYR



Rolls Dispenser
OAK \$330.00
SKU: 03DFA-000CHN
WALNUT \$385.00
SKU: 03DFA-000NYR



Spice Box Display Stand
OAK \$330.00
SKU: 03REP-000CHN
WALNUT \$385.00
SKU: 03REP-000NYR



EMPTY POCKET TRAY



500 mm
OAK \$220.00
SKU: 03TRY-500CHN
WALNUT \$250.00
SKU: 03TRY-500NYR

600 mm
OAK \$250.00
SKU: 03TRY-600CHN
WALNUT \$275.00
SKU: 03TRY-600NYR

800 mm
OAK \$275.00
SKU: 03TRY-800CHN
WALNUT \$305.00
SKU: 03TRY-800NYR

POT & PAN DRAWER ORGANIZER COMPLETE KIT

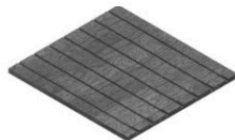

500 mm
OAK \$440.00
SKU: 03KGB-500CHN
WALNUT \$715.00
SKU: 03KGB-500NYR

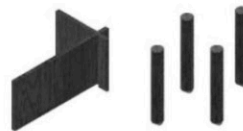

600 mm
OAK \$550.00
SKU: 03KGB-600CHN
WALNUT \$770.00
SKU: 03KGB-600NYR



800 mm
OAK \$660.00
SKU: 03KGB-800CHN
WALNUT \$825.00
SKU: 03KGB-800NYR

Ordering & Shipping

All Château products (Château Ranges, Cooktops, Hoods, Rôtisserie, Cabinetry and Accessories) are custom-ordered and quoted on a per-job basis. In our current environment, lead times are constantly changing, please consult your sales person for current lead time. Freight rates are not reflected in retail prices and will be quoted on a per-job basis. Standard freight is air freighted from France to U.S. and then truck to local delivery.

All CornuFé products (CornuFé 110 and 90) are inventoried at Middleby Residential and shipped upon order or around target delivery date. If a product is not in stock, lead time will be quoted. Standard delivery time is 1-3 weeks for products in stock. Freight rates are not reflected in retail prices and will be quoted at time of sale.

CHATEAU SERIES SHIPPING & DELIVERY

All Château units must ship via inside delivery due to weight and value. Quoted freight includes wooden crate and import costs (customs, duties and taxes).

Inside Delivery Includes:

- Insurance
- Delivery crew of 2-4 men
- Delivery up to 2 flights of stairs (includes outside and inside stairs)
** Passageway must be accessible and wide enough for delivery crew to maneuver*
- 90 minute onsite delivery time
- Placement of unit inside customer's home, three feet away from its location
- Debris removal of original crate packaging, including the wooden crate, pallet, Styrofoam, and plastic
- Delivery Monday to Friday from 8am-5pm
- Delivery within designated 5-hour delivery window, during normal business hours

CORNUFÉ SERIES SHIPPING & DELIVERY

CornuFé units may be shipped curbside/warehouse delivery or in-home delivery. Note that rates for each option are quoted by state and unit.

Curbside delivery service includes:

- Insurance
- Delivery crew of 1-2 men
- Delivery up to the driveway
- Delivery Monday to Friday from 8am-5pm
- Delivery within designated 5-hour delivery window, during normal business hours

In-home delivery is identical to Château in-home as detailed above

Items *not* covered (note the below conditions will incur additional costs):

- Delivery time of over 90 minutes
- Additional labor (more than 2 men for curbside delivery and more than 3 men for inside delivery)
- Waiting time (if recipient not home or not ready to receive order upon arrival)
- Customer pick-up
- Consignee no show
- Consignee refusal of delivery
- Consignee refusal within 24 hours of scheduled delivery
- Required use of elevator for delivery
- Unusual transportation costs – ferries, cranes, etc.
- Weekend or holiday delivery
- After hours delivery
- Specific time delivery
- Storage of unit at local distribution center

Conditions *never* covered under freight charge:

- Gas or electrical hookup
- Removal of any non-La Cornue debris
- Light assembly

Please note: It is the responsibility of the purchaser to arrange installation. La Cornue is not responsible for installation.

NATIONWIDE SERVICE & PARTS INFORMATION

For service, contact the La Cornue Service Center at 877-LACORNU(e) or 877-522-6768.

LA CORNUÉ WARRANTY AND LIMITATIONS

La Cornue warrants the original user that the product(s) manufactured are free from defects on material and workmanship for a period of five years from date of installation, not to exceed 66 months from date of shipment by Company. For extended warranty options due to delay in installation, please contact us at lacornueservice@middlebyresidential.com.

CODE COMPLIANCE INFORMATION

Château Stoves, Cooktops and Rôtisserie are UL Approved for residential use *unless otherwise noted*.

CornuFé Stoves carry CSA Approval for residential installation

Please note: According to ANSI Standard Z223, noncombustible ventilation equipment must be used in conjunction with La Cornue equipment.

LACORNUE

PURVEYORS OF HANDCRAFTED FRENCH RANGES SINCE 1908

A MEMBER OF THE MIDDLEBY RESIDENTIAL LUXURY BRAND PORTFOLIO

LA CORNUE IS DISTRIBUTED IN USA, MEXICO AND WILLIAMS-SONOMA CANADA
BY MIDDLEBY RESIDENTIAL. FOR MORE INFORMATION, OR TO FIND A DEALER NEAR YOU, PLEASE
CONNECT WITH US: [FACEBOOK.COM/LACORNUE](https://www.facebook.com/lacornue) | [INSTAGRAM.COM/LACORNUEUSA](https://www.instagram.com/lacornueusa) | [TWITTER.COM/LACORNUE](https://www.twitter.com/lacornue)

lacornueusa.com

