

An aerial, grayscale photograph of Paris, France, showing a dense urban landscape with numerous buildings and a prominent view of the Eiffel Tower on the right side. A large black rectangular box is overlaid on the upper portion of the image, containing the text 'LA CORNUÉ' in white, bold, sans-serif font. The text is framed by a white L-shaped line that starts on the left and ends at the bottom.

LA CORNUÉ

PRICES & SPECIFICATIONS

January 2023

LA CORNUE

PURVEYORS OF HANDCRAFTED FRENCH RANGES SINCE 1908

<i>G4 Château Series</i>	2
<i>Château Suprême by Ferris Rafauli</i>	16
<i>CornuFé Series</i>	18
<i>Rôtisserie</i>	25
<i>Cuisine de Château</i>	27
<i>Corner & Filler Cabinetry</i>	35
<i>Accessories</i>	35
<i>Ordering & Shipping</i>	36

G4 Château Series Ranges & Rangetops

Each Château range and cooktop is made by hand in the La Cornue atelier in France. Each piece is a unique custom creation, built with a specific owner in mind. Ranges are built to a standard height of 914 mm (36"). The legs are adjustable. The height of the range can vary from 912 mm (35.9") to 928 mm (36.5"). Custom heights are available by quote.

BURNER SPECIFICATIONS

Large Front Burners	17,000 BTUs
Small Back Burners	7,500 BTUs
Power Burner	22,000 BTUs
Large & Petite Plaque	7,500 BTUs
Lava-rock Grill	14,500 BTUs
Induction Element (2 burners)	2100 Watts*
Teppanyaki	2000 Watts

*burners can be bridged

OVEN SPECIFICATIONS

Grand Vaulted Oven	22,000 BTUs
22.6 W x 19.8 D x 11.8 H	(inches)
Vaulted Oven	22,000 BTUs
16.8 W x 19.8 D x 11.8 H	(inches)

CUSTOMIZATION TO BE SPECIFIED AT TIME OF ORDER

Voltage: Standard voltage is 240, single phase.

Fuel: Standard fuel type is Natural Gas; please specify if Propane is desired.

Altitude: Please specify if range will be installed over 2,000 feet.

Custom Height: Please specify if a custom height is desired, up to 41 inches. Price to quote.

Extended Cooktop: For a unique continuous cooktop work surface, the Stainless Steel cooktop frame may be extended laterally. Maximum total length varies based on range specified, please inquire. Price to quote.

Flushed Backsplash (additional charge): Ideal for island applications, this may be ordered in 100 mm depth (Total Depth 700 mm) or 135 mm depth (Total Depth 735 mm). Note that the standard backsplash is raised 2" above the cooktop frame. \$1000 for a seamed flush backsplash and \$6,400 for an integrated seamless flush backsplash.

Toe Kick: Stainless Steel Toe Kick is standard. A colored toe kick can be added to match the range. (See page 13 for pricing)

Brass or Copper Toe Kick: Brass or Copper Toe Kicks are available for ranges and cabinets for an upcharge. Price to Quote.

Lacquer Coating: Available on Brushed Brass, Polished Brass, Brushed Copper, Polished Copper Trims and Range Finishes.

Custom Color: \$2,800

Leather Handrail: Available in multiple colors.

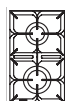

2 GAS BURNERS

Two brass burners set inside an enameled drip tray and topped with an enamel-coated cast iron grate.

Front Burner: Natural Gas 17,000 BTU / Propane Gas up to 12,500 BTU
Rear Burner: Natural Gas 7,500 BTU / Propane Gas up to 6,000 BTU

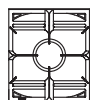

POWER BURNER

One oversized brass burner set inside an enameled drip tray with an enamel-coated cast iron grate. Ideal for oversized sauce pans, searing, sautéing, and high heat cooking.

Natural Gas 22,000 BTU / Propane Gas up to 22,000 BTU

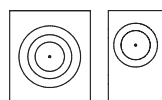

PLAQUE "FRENCH TOP": LARGE, PETITE

One gas burner installed beneath a solid cast iron top, serving as the heat source for the entire cast iron surface. The cast iron plaque becomes the cooking center and offers variable heat zones with the strongest heat in the center, directly above the burner, and diffusing outwards. Allows for multiple sauce pans above a single indirect heat source.

Natural Gas 7,500 BTU / Propane Gas up to 7,500 BTU

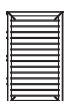

LAVA-ROCK GRILL

Linear gas burner running front-to-back set beneath a bed of natural lava rocks and topped with an enamel-coated open-style grill.

Natural Gas 14,500 BTU / Propane Gas up to 14,500 BTU



TEPPANYAKI

Flat, solid, griddle-style cooking surface heated by electricity to create a consistent and solid cooking surface ideal for steak, seafood, shrimp, rice, eggs and vegetables with a minimum temperature of 140°F and a maximum temperature of 482°F.



CERAMIC GLASS INDUCTION

Ceramic glass induction hob features 2 identical cooking areas, 220 x 180 mm 2100 watts, 3700 watts max

Induction element incurs an upcharge of \$3,000 per element



ALL INDUCTION COOKTOP

Available on the 150, 120 and 90 ranges only. The 150 and 120 cooktops feature a five burner cooktop and the 90 features a 4 burner cooktop. When this cooktop is specified, the ovens will always be electric.

GRAND PALAIS 180: G48

1800 W x 700 D x 914 H (mm)
 70.9 W x 27.6 D x 36 H (inches)
 Approx. 710 lb. uncrated, 1320 lb. crated
 Choice of 7 top configurations
 Starting from \$78,800

STANDARD FEATURES INCLUDE:

- 1 Grand Vaulted Gas Oven with Electric Broiler (left)
- 1 Grand Vaulted Electric Oven with Electric Broiler (right)

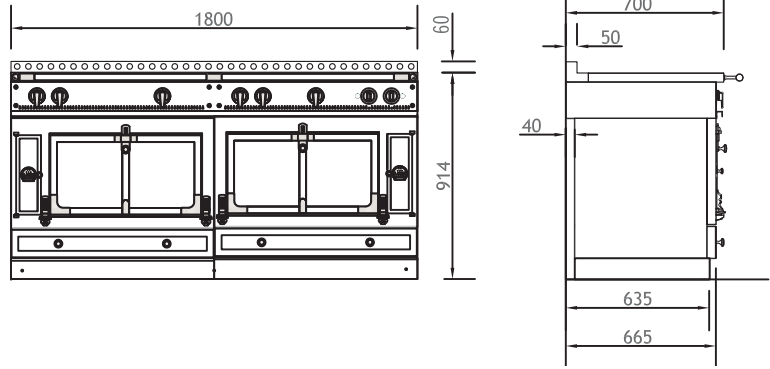

GRAND PALAIS RANGETOP 180: T48

1800 W x 700 D x 200 H (mm)
 70.9 W x 27.6 D x 7.9 H (inches)
 Approx. 290 lb. uncrated, 450 lb. crated
 Choice of 7 top configurations
 Starting from \$33,500

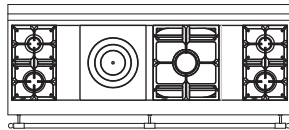
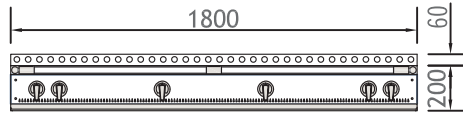

180 US N1

- 2 gas burners (small burner at the back)
- 1 Plaque "French Top" (large)
- 1 maxi burner
- 2 gas burners (small burner at the back)

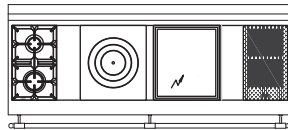

180 US N2*

- 2 gas burners (small burner at the back)
- 1 Plaque "French Top" (large)
- 1 large electric Teppan-Yaki
- 2 induction plates

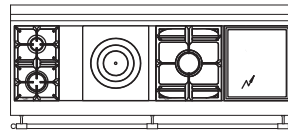

180 US N3

- 2 gas burners (small burner at the back)
- 1 Plaque "French Top" (large)
- 1 maxi burner
- 1 large electric Teppan-Yaki

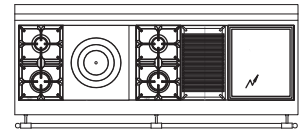

180 US N5

- 2 gas burners (small burner at the back)
- 1 Plaque "French Top" (large)
- 2 gas burners (small burner at the back)
- 1 gas lava-rock grill
- 1 large electric Teppan-Yaki

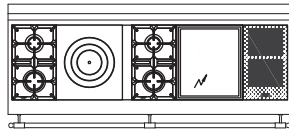

180 US N8*

- 2 gas burners (small burner at the back)
- 1 Plaque "French Top" (large)
- 2 gas burners (small burner at the back)
- 1 large electric Teppan-Yaki
- 2 induction plates

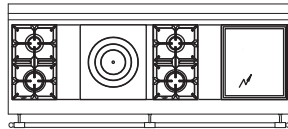

180 US N9

- 2 gas burners (small burner at the back)
- 1 Plaque "French Top" (large)
- 2 gas burners (small burner at the back)
- 1 large electric Teppan-Yaki

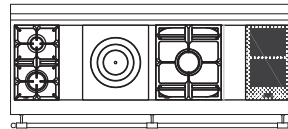

180 US NM*

- 2 gas burners (small burner at the back)
- 1 Plaque "French Top" (large)
- 1 maxi burner
- 2 induction plates

CHÂTEAU 165: G46

1650 W x 700 D x 914 H (mm)
 65.0 W x 27.6 D x 36 H (inches)
 Approx. 640 lb. uncrated, 1280 lb. crated
 Choice of 5 top configurations
 Starting from \$73,900

STANDARD FEATURES INCLUDE:

- 1 Grand Vaulted Gas Oven with Electric Broiler (left)
- 1 Vaulted Electric Oven with Electric Broiler (right)

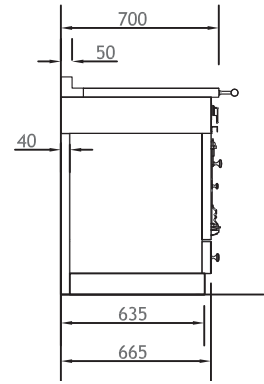
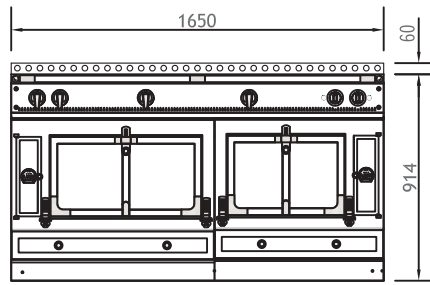

CHÂTEAU RANGETOP 165: T46

1650 W x 700 D x 200 H (mm)
 65.0 W x 27.6 D x 7.9 H (inches)
 Approx. 290 lb. uncrated, 400 lb. crated
 Choice of 5 top configurations
 Starting from \$32,300

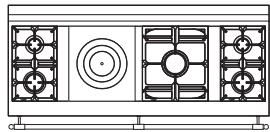
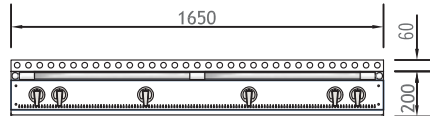

165 US L1

- 2 gas burners (small burner at the back)
- 1 Plaque "French Top" (large)
- 1 maxi burner
- 2 gas burners (small burner at the back)

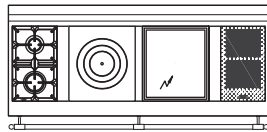

165 US L2*

- 2 gas burners (small burner at the back)
- 1 Plaque "French Top" (large)
- 1 large electric Teppan-Yaki
- 2 induction plates

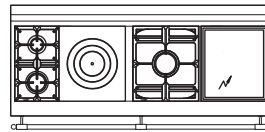

165 US L3

- 2 gas burners (small burner at the back)
- 1 Plaque "French Top" (large)
- 1 maxi burner
- 1 large electric Teppan-Yaki

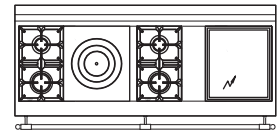

165 US L9

- 2 gas burners (small burner at the back)
- 1 Plaque "French Top" (large)
- 2 gas burners (small burner at the back)
- 1 large electric Teppan-Yaki

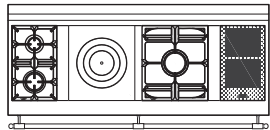

165 US LM*

- 2 gas burners (small burner at the back)
- 1 Plaque "French Top" (large)
- 1 maxi burner
- 2 induction plates

CHÂTEAU 150: G45

1500 W x 700 D x 914 H (mm)
 59.1 W x 27.6 D x 36 H (inches)
 Approx. 620 lb. uncrated, 1230 lb. crated
 Choice of 9 top configurations
 Traditional Cooktop Configurations starting from \$68,400
 All Induction Cooktop Configuration starting from \$75,200

TRADITIONAL CHÂTEAU COOKTOP CONFIGURATION
 RANGES INCLUDE:

- 1 Vaulted Gas Oven with Electric Broiler (left)
- 1 Vaulted Electric Oven with Electric Broiler (right)

ALL INDUCTION CHÂTEAU COOKTOP CONFIGURATION RANGE INCLUDES:
 2 Vaulted Electric Ovens with Electric Broilers

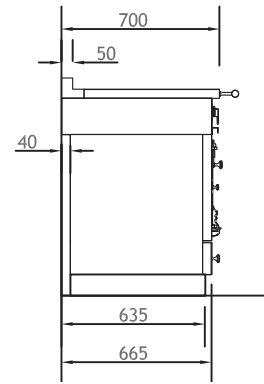
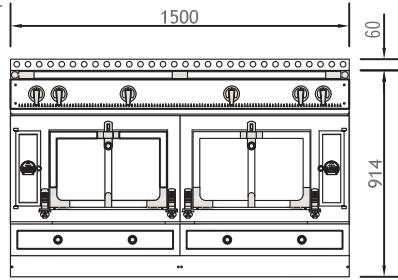

CHÂTEAU RANGETOP 150: T45

1500 W x 700 D x 200 H (mm)
 59.1 W x 27.6 D x 7.9 H (inches)
 Approx. 220 lb. uncrated, 350 lb. crated
 Choice of 9 top configurations
 Traditional Cooktop Configurations starting From \$24,500
 All Induction Cooktop Configuration starting from \$27,000

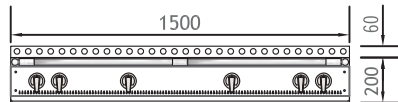

TRADITIONAL COOKTOP CONFIGURATION OPTIONS

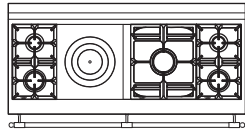

150 US K1

- 2 gas burners (small burner at the back)
- 1 Plaque "French Top" (large)
- 1 maxi burner
- 2 gas burners (small burner at the back)

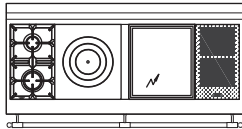

150 US K2*

- 2 gas burners (small burner at the back)
- 1 Plaque "French Top" (large)
- 1 large electric Teppan-Yaki
- 2 induction plates

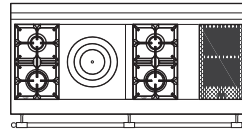

150 US K3*

- 2 gas burners (small burner at the back)
- 1 Plaque "French Top" (large)
- 2 gas burners (small burner at the back)
- 2 induction plates

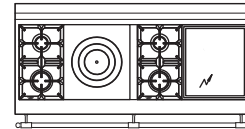

150 US K4

- 2 gas burners (small burner at the back)
- 1 Plaque "French Top" (large)
- 2 gas burners (small burner at the back)
- 1 large electric Teppan-Yaki

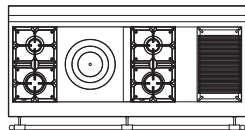

150 US K5

- 2 gas burners (small burner at the back)
- 1 Plaque "French Top" (large)
- 2 gas burners (small burner at the back)
- 1 gas lava-rock grill

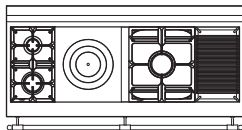

150 US K6

- 2 gas burners (small burner at the back)
- 1 Plaque "French Top" (large)
- 1 maxi burner
- 1 gas lava-rock grill

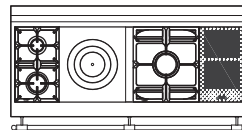

150 US KM*

- 2 gas burners (small burner at the back)
- 1 Plaque "French Top" (large)
- 1 maxi burner
- 2 induction plates

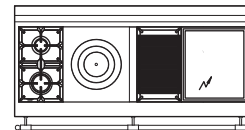

150 US KH

- 2 gas burners (small burner at the back)
- 1 Plaque "French Top" (large)
- 1 gas lava-rock grill
- 1 large electric Teppan-Yaki

ALL INDUCTION COOKTOP CONFIGURATION OPTION

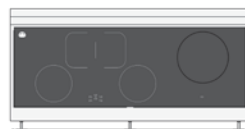

150 US KI

- Full Induction 150 Plate includes:
- 2 rectangular burners - both burners can be bridged together
 - 2 circular burners
 - 1 large circular burner

CHÂTELET 135 WD: G43

1350 W x 700 D x 914 H (mm)
 53.15 W x 27.6 D x 36 H (inches)
 Approx. 500 lb. uncrated, 800 lb. crated
 Choice of 7 top configurations
 Starting from \$63,900

STANDARD FEATURES INCLUDE:

- 1 Grand Vaulted Gas Oven with Electric Broiler OR
- 1 Grand Vaulted Electric oven with Electric Broiler
- AND
- 1 Electric Warming Drawer** with temperature ranging from 130 – 240 F

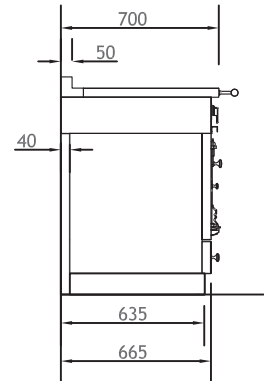
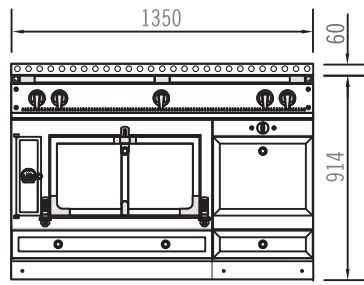

CHÂTELET 135 RANGETOP: T43

1350 W x 700 D x 200 H (mm)
 53.15 W x 27.6 D x 7.9 H (inches)
 Approx. 220 lb. uncrated, 320 lb. crated
 Choice of 7 top configurations
 Starting from \$22,400

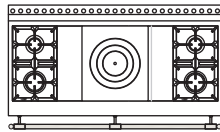
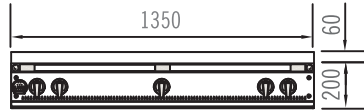

135 US H0

- 2 gas burners (small burner at the back)
- 1 Plaque "French Top" (large)
- 2 gas burners (small burner at the back)

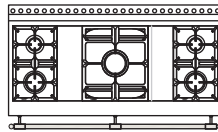

135 US H1

- 2 gas burners (small burner at the back)
- 1 maxi burner
- 2 gas burners (small burner at the back)

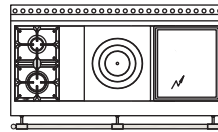

135 US H2

- 2 gas burners (small burner at the back)
- 1 Plaque "French Top" (large)
- 1 large electric Teppan-Yaki

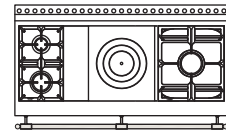

135 US H3

- 2 gas burners (small burner at the back)
- 1 Plaque "French Top" (large)
- 1 maxi burner

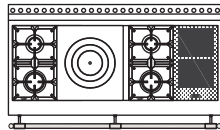

135 US HC*

- 2 gas burners (small burner at the back)
- 1 Plaque "French Top" (large)
- 2 gas burners (small burner at the back)
- 2 induction plates

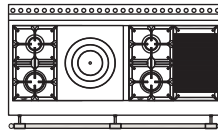

135 US H6

- 2 gas burners (small burner at the back)
- 1 Plaque "French Top" (large)
- 2 gas burners (small burner at the back)
- 1 gas lava-rock grill

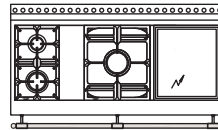

135 US HF

- 2 gas burner (small burner at the back)
- 1 maxi burner
- 1 large electric Teppan-Yaki

CHÂTEAU 120: G42

1200 W x 700 D x 914 H (mm)
 47.2 W x 27.6 D x 36 H (inches)
 Approx. 490 lb. uncrated, 780 lb. crated
 Choice of 8 top configurations
 Traditional 3-Element Cooktop configuration starting from \$59,400
 Traditional 4-Element with induction Cooktop configuration starting from \$64,000
 All Induction Cooktop configuration starting from \$65,400

TRADITIONAL CHÂTEAU COOKTOP CONFIGURATION RANGES INCLUDE:
 1 Vaulted Gas Oven with Electric Broiler (left)
 1 Vaulted Electric Oven with Electric Broiler (right)

ALL INDUCTION CHÂTEAU COOKTOP CONFIGURATION RANGE INCLUDES:
 2 Vaulted Electric Ovens with Electric Broilers

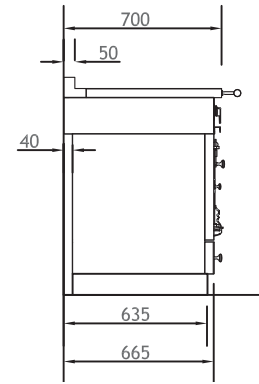
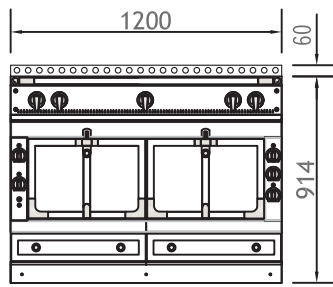

CHÂTEAU RANGETOP 120: T42

1200 W x 700 D x 200 H (mm)
 47.2 W x 27.6 D x 7.9 H (inches)
 Approx. 200 lb. uncrated, 300 lb. crated
 Choice of 8 top configurations
 Traditional 3-Element Cooktop configurations starting from \$20,300
 Traditional 4-Element with induction Cooktop configuration starting from \$24,900
 All Induction Cooktop configuration starting from \$22,400

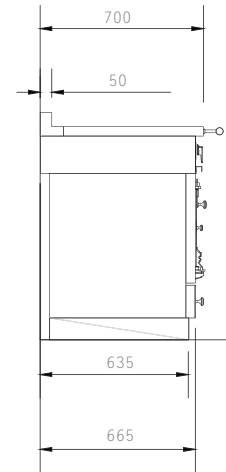
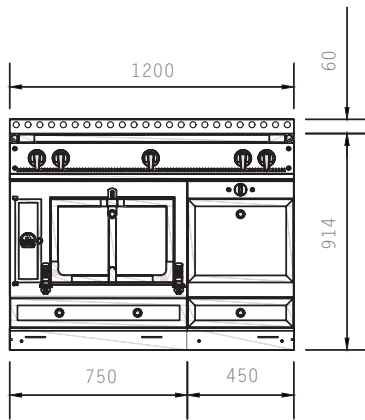
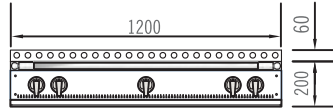

CHÂTELET 120 WD: G41

1200 W x 700 D x 914 H (mm)
 47.2 W x 27.6 D x 36 H (inches)
 Approx. 500 lb. uncrated, 800 lb. crated
 Choice of 8 top configurations
 Traditional 3-Element Cooktop configuration starting from \$57,900
 Traditional 4-Element with induction Cooktop configuration starting from \$62,500
 All Induction Cooktop configuration starting from \$63,700

TRADITIONAL CHÂTEAU COOKTOP CONFIGURATION RANGES INCLUDE:
 1 Vaulted Gas Oven with Electric Broiler OR
 1 Vaulted Electric oven with Electric Broiler
 AND
 1 Electric Warming Drawer** with temperature ranging from 130 – 240 F

ALL INDUCTION CHÂTEAU COOKTOP CONFIGURATION RANGE INCLUDES:
 1 Vaulted Electric Oven with Electric Broilers
 AND
 1 Electric Warming Drawer** with temperature ranging from 130 – 240 F

TRADITIONAL COOKTOP CONFIGURATION OPTIONS

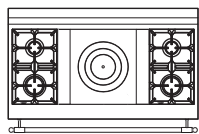

120 US E0
 2 gas burners (small burner at the back)
 1 Plaque "French Top" (large)
 2 gas burners (small burner at the back)

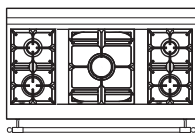

120 US E1
 2 gas burners (small burner at the back)
 1 maxi burner
 2 gas burners (small burner at the back)

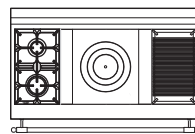

120 US E2
 2 gas burners (small burner at the back)
 1 Plaque "French Top" (large)
 1 gas lava-rock grill

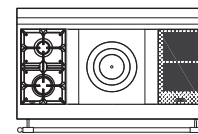

120 US E4*
 2 gas burners (small burner at the back)
 1 Plaque "French Top" (large)
 2 induction plates

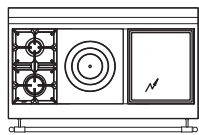

120 US E5
 2 gas burners (small burner at the back)
 1 Plaque "French Top" (large)
 1 large electric Teppan-Yaki

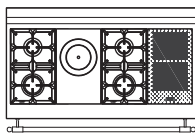

120 US ED*
 2 gas burners (small burner at the back)
 1 Plaque "French Top" (small)
 2 gas burners (small burner at the back)
 2 induction plates

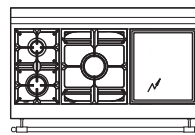

120 US EF
 2 gas burners (small burner at the back)
 1 maxi burner
 1 large electric Teppan-Yaki

ALL INDUCTION COOKTOP CONFIGURATION OPTION



120 S EI
 Full Induction 120 Plate includes:
 2 rectangular burners - both burners can be bridged together
 2 circular burners
 1 large circular burner

CHÂTEAU 90: G49

900 W x 700 D x 914 H (mm)
 35.4 W x 27.6 D x 36 H (inches)
 Approx. 330 lb. uncrated, 600 lb. crated
 Choice of 6 top configurations
 Traditional Cooktop configurations starting from \$45,500
 All Induction Cooktop configuration starting from \$50,000

TRADITIONAL CHÂTEAU COOKTOP CONFIGURATION RANGES INCLUDE:

1 Grand Vaulted Gas Oven with Electric Broiler *or*
 1 Grand Vaulted Electric Oven with Electric Broiler

ALL INDUCTION CHÂTEAU COOKTOP CONFIGURATION RANGE INCLUDES:

2 Vaulted Electric Ovens with Electric Broilers

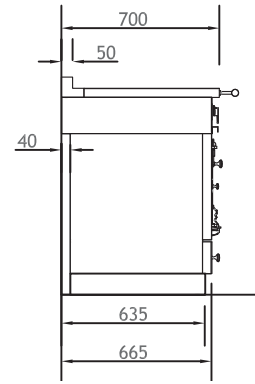
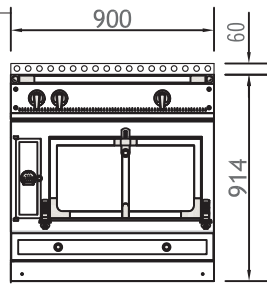

CHÂTEAU RANGETOP 90: T49

900 W x 700 D x 200 H (mm)
 35.4 W x 27.6 D x 7.9 H (inches)
 Approx. 150 lb. uncrated, 250 lb. crated
 Choice of 6 top configurations
 Traditional Cooktop configurations starting from \$19,100
 All Induction Cooktop configuration starting from \$21,000

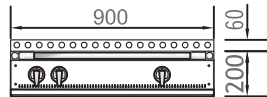

TRADITIONAL COOKTOP CONFIGURATION OPTIONS

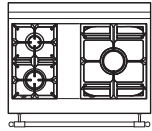

90 US C1

2 gas burners (small burner at the back)
 1 maxi burner

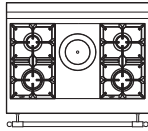

90 US C2

2 gas burners (small burner at the back)
 1 Plaque "French Top" (small)
 2 gas burners (small burner at the back)

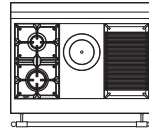

90 US C3

2 gas burners (small burner at the back)
 1 Plaque "French Top" (small)
 1 gas lava-rock grill

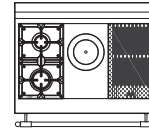

90 US C5*

2 gas burners (small burner at the back)
 1 Plaque "French Top" (small)
 2 induction plates

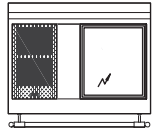

90 US CC*

2 induction plates
 1 large electric Teppan-Yaki

ALL INDUCTION COOKTOP CONFIGURATION OPTION

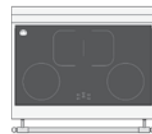

90 US CI

Full Induction 90 Plate includes:
 2 rectangular burners - both burners can be bridged together
 2 circular burners

CHÂTEAU 75: G47

750 W x 700 D x 914 H (mm)
29.5 W x 27.6 D x 36 H (inches)
Approx. 290 lb. uncrated, 600 lb. crated
Choice of 5 top configurations
All-electric range available
Starting from \$36,000

STANDARD FEATURES INCLUDE:

1 Vaulted Gas Oven with Electric Broiler *or*
1 Vaulted Electric Oven with Electric Broiler

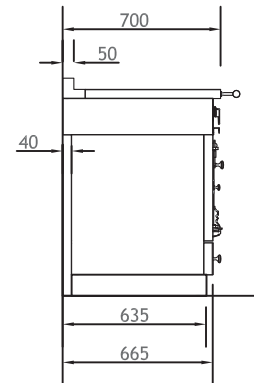
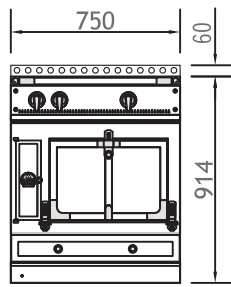

CHÂTEAU RANGETOP 75: T47

750 W x 700 D x 200 H (mm)
29.5 W x 27.6 D x 7.9 H (inches)
Approx. 130 lb. uncrated, 250 lb. crated
Choice of 5 top configurations
Starting from \$13,900

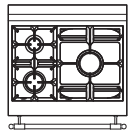
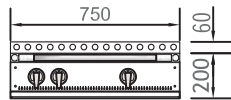

75 US B1

2 gas burners (small burner at the back)
1 maxi burner

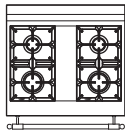

75 US B2

2 gas burners (small burner at the back)
2 gas burners (small burner at the back)

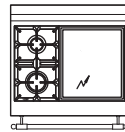

75 US B3

2 gas burners (small burner at the back)
1 large electric Teppan-Yaki

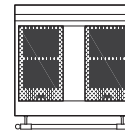

75 US BA*

2 induction plates
2 induction plates

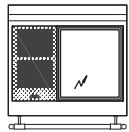

75 US BB*

2 induction plates
1 large electric Teppan-Yaki

Château Series Hoods

Since every installation is unique, Hotte Château hoods are sold without a blower system, as a shell-only. Please contact your local HVAC contractor to discuss specific installation requirements. La Cornue does also offer motorized Château wall-mounted hood models which include a motorized factory installed blower (a 1200 CFM blower for all 2 oven cookers and a 600 CFM blower for all 1 oven cookers). In the event you choose a custom hood, La Cornue also offers hood inserts with lights, blowers and a remote control.

HOTTE CHÂTEAU

Traditional wall mounted hood. Island Hoods are also available. Custom Hoods available by quote. Hood height may be increased up to 1500 mm/ 59 inches by adding height to the upper band (total maximum height would be 2250 mm/88.5 inches).

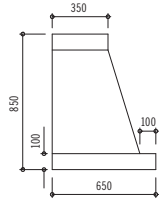

Standard Configuration Wall Hood
Side View

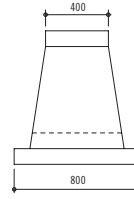

Standard Configuration Island Hood
Side View

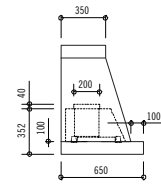

Standard Configuration Motorized Wall Hood
Side View

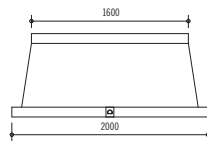

Hotte Grand Palais 180: H20TO
2000 W x 850 H x 650 D (mm)
78.7 W x 33.5 H x 25.6 D (inches)
Shell-Only Starting from \$17,100
Motorized Hood Starting from \$21,300
Island configuration: H20CO
Starting from \$29,300

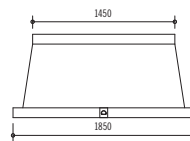

Hotte Château 165: H18TO
1850 W x 850 H x 650 D (mm)
72.8 W x 33.5 H x 25.6 D (inches)
Shell-Only Starting from \$16,000
Motorized Hood Starting from \$20,200
Island configuration: H18CO
Starting from \$27,500

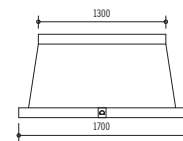

Hotte Château 150: H17TO
1700 W x 850 H x 650 D (mm)
66.9 W x 33.5 H x 25.6 D (inches)
Shell-Only Starting from \$15,000
Motorized Hood Starting from \$18,800
Island configuration: H17CO
Starting from \$25,800

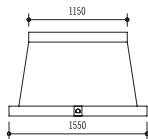

Hotte Château 135: H15TO
1550 W x 850 H x 650 D (mm)
61.0 W x 33.5 H x 25.6 D (inches)
Shell-Only Starting from \$13,800
Motorized Hood Starting from \$17,900
Island configuration: H15CO
Starting from \$23,800

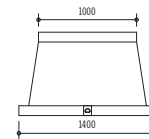

Hotte Château 120: H42TO
1400 W x 850 H x 650 D (mm)
55.1 W x 33.5 H x 25.6 D (inches)
Shell-Only Starting from \$13,500
Motorized Hood Starting from \$17,300
Island configuration: H42CO
Starting from \$23,200

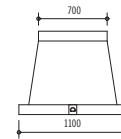

Hotte Château 90: H11TO
1100 W x 850 H x 650 D (mm)
43.3 W x 33.5 H x 25.6 D (inches)
Shell-Only Starting from \$11,300
Motorized Hood Starting from \$14,800
Island configuration: H11CO
Starting from \$19,400

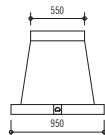

Hotte Château 75: H95TO
950 W x 850 H x 650 D (mm)
37.4 W x 33.5 H x 25.6 D (inches)
Shell-Only Starting from \$10,900
Motorized Hood Starting from \$14,400
Island configuration: H95CO
Starting from \$18,800

HOTTE CHÂTEAU WITH STRAPPING - MOTORIZED

Traditional wall mounted hood. Custom Hood heights are available by quote. Hood height may be increased up to 1500 mm/ 59 inches by adding height to the upper band (total maximum height would be 2250 mm/88.5 inches).

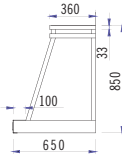

Standard Configuration Motorized Wall Hood
Side View

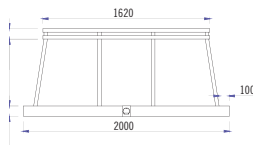

Hotte Grand Palais 180: H20T0S M
2000 W x 850 H x 650 D (mm)
78.7 W x 33.5 H x 25.6 D (inches)
Motorized Hood Starting from \$25,600

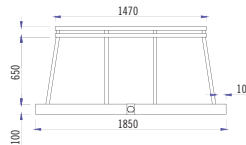

Hotte Château 165: H18T0S M
1850 W x 850 H x 650 D (mm)
72.8 W x 33.5 H x 25.6 D (inches)
Motorized Hood Starting from \$24,300

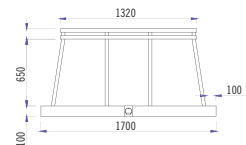

Hotte Château 150: H17T0S M
1700 W x 850 H x 650 D (mm)
66.9 W x 33.5 H x 25.6 D (inches)
Motorized Hood Starting from \$22,600

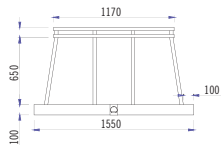

Hotte Château 135: H15T0S M
1550 W x 850 H x 650 D (mm)
61.0 W x 33.5 H x 25.6 D (inches)
Motorized Hood Starting from \$21,400

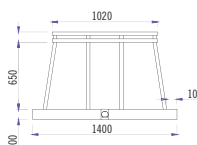

Hotte Château 120: H42T0S M
1400 W x 850 H x 650 D (mm)
55.1 W x 33.5 H x 25.6 D (inches)
Motorized Hood Starting from \$20,800

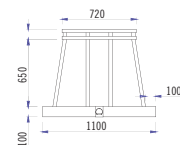

Hotte Château 90: H11T0S M
1100 W x 850 H x 650 D (mm)
43.3 W x 33.5 H x 25.6 D (inches)
Motorized Hood Starting from \$17,700

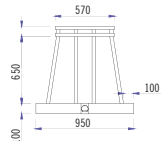

Hotte Château 75: H95T0S M
950 W x 850 H x 650 D (mm)
37.4 W x 33.5 H x 25.6 D (inches)
Motorized Hood Starting from \$17,300

Château Hood Inserts

In 2020, La Cornue introduced hood inserts that are available for every size range in the Château Series. All Château inserts include an internal blower, baffle filters, LED lights, remote control, and 3 speed touch buttons for fan and light control. The Château inserts should be ordered with your range order, and are designed for use in custom hoods. They are NOT compatible with Hotte Château hoods.

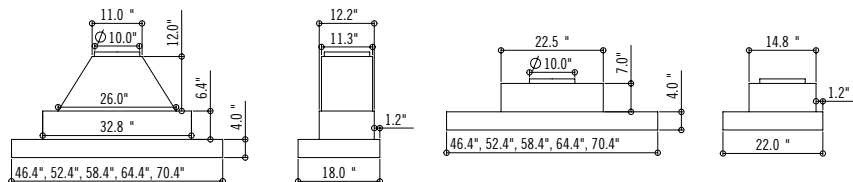

Château Hood Insert: 180LC122

Compatible with G48 & T48
70 3/8" w x 22" d Grade 304 Stainless Steel Hood Insert
Lights: 4 LED
Filters: Baffle
Internal Blower: 1200 CFM
Duct Size: 10"
Remote Control: Yes
Approx Weight: 101 lbs
Retail: \$2,550

Château Hood Insert: 165LC118

Compatible with G46 & T46
64 3/8" w x 18" d Grade 304 Stainless Steel Hood Insert
Lights: 3 LED
Filters: Baffle
Internal Blower: 1200 CFM
Duct Size: 10"
Remote Control: Yes
Approx Weight: 107 lbs
Retail: \$2,200

Château Hood Insert: 180LC118

Compatible with G48 & T48
70 3/8" w x 18" d Grade 304 Stainless Steel Hood Insert
Lights: 4 LED
Filters: Baffle
Internal Blower: 1200 CFM
Duct Size: 10"
Remote Control: Yes
Approx Weight: 119 lbs
Retail: \$2,425

Château Hood Insert: 150LC118

Compatible with G45 & T45
58 3/8" w x 18" d Grade 304 Stainless Steel Hood Insert
Lights: 3 LED
Filters: Baffle
Internal Blower: 1200 CFM
Duct Size: 10"
Remote Control: Yes
Approx Weight: 95 lbs
Retail: \$2,000

Château Hood Insert: 150LC122

Compatible with G45 & T45
58 3/8" w x 22" d Grade 304 Stainless Steel Hood Insert
Lights: 3 LED
Filters: Baffle
Internal Blower: 1200 CFM
Duct Size: 10"
Remote Control: Yes
Approx Weight: 75 lbs
Retail: \$2,100

Château Hood Insert: 165LC122

Compatible with G46 & T46
64 3/8" w x 22" d Grade 304 Stainless Steel Hood Insert
Lights: 3 LED
Filters: Baffle
Internal Blower: 1200 CFM
Duct Size: 10"
Remote Control: Yes
Approx Weight: 88 lbs
Retail: \$2,325

Château Hood Insert: 135LC118

Compatible with G43 & T43
52 3/8" w x 18" d Grade 304 Stainless Steel Hood Insert
Lights: 3 LED
Filters: Baffle
Internal Blower: 1200 CFM
Duct Size: 10"
Remote Control: Yes
Approx Weight: 83 lbs
Retail: \$1,875

Château Hood Insert: 135LC122

Compatible with G43 & T43
52 3/8" w x 22" d Grade 304 Stainless Steel Hood Insert
Lights: 3 LED
Filters: Baffle
Internal Blower: 1200 CFM
Duct Size: 10"
Remote Control: Yes
Approx Weight: 71 lbs
Retail: \$2,000

Château Hood Insert: 120LC118

Compatible with G42, G41 & T42
46 3/8" w x 18" d Grade 304 Stainless Steel Hood Insert
Lights: 3 LED
Filters: Baffle
Internal Blower: 1200 CFM
Duct Size: 10"
Remote Control: Yes
Approx Weight: 71 lbs
Retail: \$1,775

Château Hood Insert: 120LC122

Compatible with G42, G41 & T42
46 3/8" w x 22" d Grade 304 Stainless Steel Hood Insert
Lights: 3 LED
Filters: Baffle
Internal Blower: 1200 CFM
Duct Size: 10"
Remote Control: Yes
Approx Weight: 67 lbs
Retail: \$1,775

Château Hood Insert: 90LC118

Compatible with G49 & T49
34 3/8" w x 18" d Grade 304 Stainless Steel Hood Insert
Lights: 2 LED
Filters: Baffle
Internal Blower: 600 CFM
Duct Size: 8"
Remote Control: Yes
Approx Weight: 40 lbs
Retail: \$1,225

(See page 23 for line drawing)

Château Hood Insert: 90LC122

Compatible with G49 & T49
34 3/8" w x 22" d Grade 304 Stainless Steel Hood Insert
Lights: 2 LED
Filters: Baffle
Internal Blower: 600 CFM
Duct Size: 8"
Remote Control: Yes
Approx Weight: 46 lbs
Retail: \$1,550

(See page 23 for line drawing)

Château Hood Insert: 75LC118

Compatible with G47 & T47
28 3/8" w x 18" d Grade 304 Stainless Steel Hood Insert
Lights: 2 LED
Filters: Baffle
Internal Blower: 600 CFM
Duct Size: 8"
Remote Control: Yes
Approx Weight: 36 lbs
Retail: \$1,225

(See page 23 for line drawing)

CHATEAU ENAMEL COLORS

STANDARD COLORS *(included in listed prices)*

M	Brilliant Black
D	Dark Navy Blue
N	Matte Black
r	Royal Blue
I	Stainless Steel

PREMIUM COLORS *(additional charge)*

Y	Almond Green
V	Antique White
F	Antique White w/ Flowers
H	Azulejo Blue
Z	Imperial Green
c	Chocolate
k	Cocoa
O	Eggplant
B	French Blue
e	Greige
j	Icy Blue
U	Lafayette Blue
L	Lavender Blue
I	Milk White/Lacté
n	Moss Green
g	Pebble Grey
P	Pistachio
W	Pure White
u	Quintessential Teal (Brilliant)
s	Quintessential Teal (Matte)
T	Rush Green
E	Summer Blue
h	Truffle
5	Ultra Black
v	Basilica
4	Blanc
i	Pasture
x	Provincial
G	Roquefort
a	Roux (Matte)
z	Sovereign

PREMIUM COLORS *continued*

6	Tapestry
9	Tranquille
jw	Jerez White
gb	Goodwood Blue
gg	Grand Prix Grey
mg	Monaco Grey
ss	Silverstone Noir
sn	Sarthe Noir
S	Custom Color

DELUXE COLORS *(additional charge)*

m	Aquamarine Blue
w	Matte White
K	Sahara Sand

PREMIUM DELUXE COLORS *(additional charge)*

C	Copper (Brushed)
d	Pebbled Stainless

PRICED TO QUOTE

X	Carbon Fiber <i>(special premium deluxe pricing applies)</i>
----------	--

WOOD CABINETRY

EPI and EPH are available, light oak, dark walnut, wrapped in stainless steel, copper or painted to match the range.

COLORED TOE KICK TO MATCH THE RANGE

Château 180	\$ 1,850.00
Château 165	\$ 1,750.00
Château 150	\$ 1,700.00
Chatelet 135	\$ 1,600.00
Château 120	\$ 1,500.00
Chatelet 120	\$ 1,500.00
Château 90	\$ 1,350.00
Château 75	\$ 1,250.00

Château Series Color & Trim Options

La Cornue ranges, cooktops, hoods, cabinets and accessories are available in a variety of solid metal trim living finishes, which patina naturally over time. Below is a pictorial diagram of the various trim options La Cornue offers. For an additional cost, please select from the Premium, Deluxe or Custom body colors as well as the Premium, Custom and Copper trim options (see Page 15 for trim pricing categories).

TRIM, ACCENT & RAIL LOCATIONS

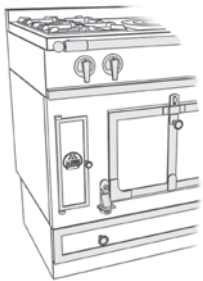

B: Polished Brass Trim
L: Brushed Brass Trim
K: Polished Copper Trim

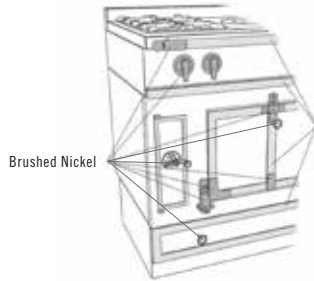

Brushed Nickel

N: Brushed Stainless Steel & Brushed Nickel

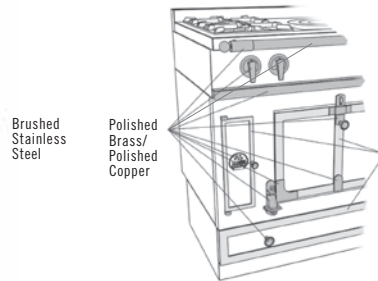

Polished Brass/Polished Copper

Y: Polished Brass & Brushed Stainless Steel
R: Polished Copper & Brushed Stainless Steel

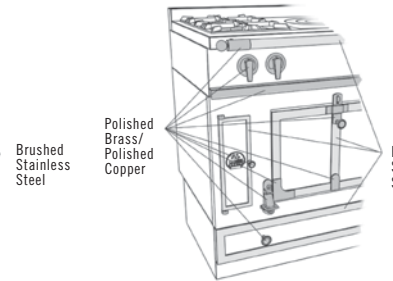

Brushed Stainless Steel

Brushed Stainless Steel

D: Polished Brass & Brushed Stainless Steel with Brushed Stainless Handrail
V: Polished Copper & Brushed Stainless Steel with Brushed Stainless Handrail

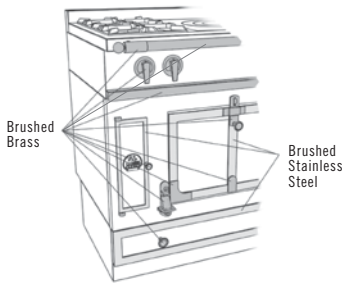

Brushed Brass

Brushed Stainless Steel

S: Brushed Brass & Stainless Steel

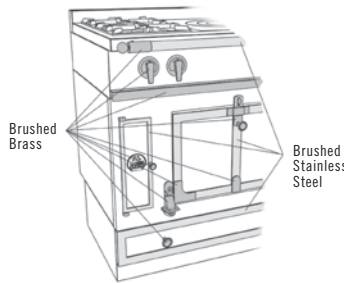

Brushed Brass

Brushed Stainless Steel

A: Brushed Brass & Stainless Steel with Brushed Stainless Handrail

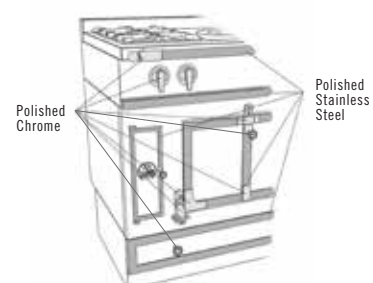

Polished Chrome

Polished Stainless Steel

C: Polished Chrome & Polished Stainless Steel

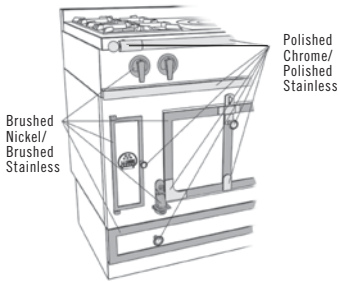

Brushed Nickel/Brushed Stainless

Polished Chrome/Polished Stainless

M: Brushed Nickel/Brushed Stainless & Polished Chrome/Polished Stainless

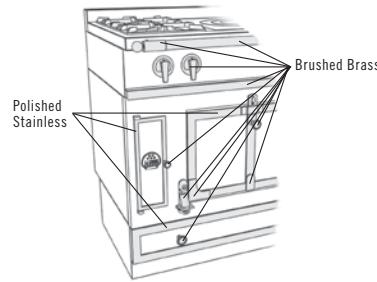

Polished Stainless

Brushed Brass

P: Polished Stainless & Brushed Brass with Brushed Brass Handrail

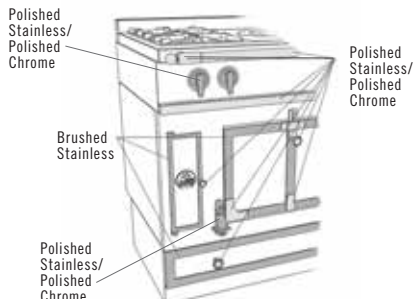

Polished Stainless/Polished Chrome

Brushed Stainless

Polished Stainless/Polished Chrome

O: Polished Chrome & Brushed Stainless Steel with Polished Stainless Steel Handrail

CHÂTEAU TRIM OPTIONS (Note: All metals are natural metals and will patina over time. Lacquer trims are available for the Château line only.)

STANDARD TRIMS (included in listed prices)

Trim	Accents	Rails
S Brushed Stainless Steel	Brushed Brass	Brushed Brass
Y Brushed Stainless Steel	Polished Brass	Polished Brass
A Brushed Stainless Steel	Brushed Brass	Brushed Stainless Steel
D Brushed Stainless Steel	Polished Brass	Brushed Stainless Steel
B Polished Brass	Polished Brass	Polished Brass
L Brushed Brass	Brushed Brass	Brushed Brass
N Brushed Stainless Steel	Brushed Nickel	Brushed Stainless Steel
M Brushed Stainless Steel	Polished Chrome/ Brushed Nickel	Polished Stainless Steel

PREMIUM TRIMS (additional charge)

Trim	Accents	Rails
J Matte Black	Matte Black	Matte Black
E Black Shiny Chrome	Black Shiny Chrome	Black Shiny Chrome
H Bronze	Bronze	Bronze
C Polished Stainless Steel	Polished Chrome	Polished Stainless Steel
O Brushed Stainless Steel	Polished Chrome	Polished Stainless Steel
P Polished Stainless Steel	Brushed Brass	Brushed Brass

COPPER TRIMS (additional charge)

Trim	Accents	Rails
V Brushed Stainless Steel	Polished Copper	Brushed Stainless Steel
K Polished Copper	Polished Copper	Polished Copper
R Brushed Stainless Steel	Polished Copper	Polished Copper
k Brushed Copper	Brushed Copper	Brushed Copper

Combine any La Cornue Trim options to create your own unique combination.

FLAMBERGE RÔTISSERIE TRIM OPTIONS

	Trim	Knobs
STANDARD	S Brushed Stainless Steel	Brushed Brass
	Y Brushed Stainless Steel	Polished Brass
	N Brushed Stainless Steel	Brushed Nickel
	B Polished Brass	Polished Brass
	L Brushed Brass	Brushed Brass
PREMIUM	C Polished Stainless Steel	Polished Chrome
	O Brushed Stainless Steel	Polished Chrome
	J Matte Black	Matte Black
	E Black Shiny Chrome	Black Shiny Chrome
	H Bronze	Bronze
COPPER	P Polished Stainless Steel	Brushed Brass
	R Brushed Stainless Steel	Polished Copper
	K Polished Copper	Polished Copper

Rod supports are always in Polished Aluminum

CHÂTEAU I.D. PLATE

Château 180, 165, 150

2 I.D. Plates 2 Lines per I.D. Plate,
15 Characters per line

Château 135, 120, 90, 75, rangetops, Flamberge & Hotte Château Hoods

1 I.D. Plate 2 Lines per I.D. Plate,
15 Characters per line

Château Suprême by Ferris Rafauli

The Château range is an icon of the French art of living throughout the world. Reimagined by Ferris Rafauli, this contemporary version is the ultimate in sophistication. To create it, the designer considered and revised each element of the range to bring out its most distinctive characteristics, taking the precision of the lines and details to a whole new level.

CHÂTEAU SUPRÊME GRAND PALAIS 180

1800 W x 700 D x 914 H (mm)
70.9 W x 27.6 D x 36 H (inches)
Approx. 710 lb. uncrated, 1320 lb. crated

OPTIONS:

- Two optional warming drawer cabinets, each featuring an electric teppanyaki *or* stainless steel tops
- Six cooktop configurations
- Château Suprême 180 hood, finished to match the range, or in an optional leather-covered exterior

OVENS:

1 Grand Vaulted Gas Oven with Electric Broiler
22.6W x 19.8D x 11.8H – 3.1 cubic feet (left)
1 Grand Vaulted Electric Oven with Electric Broiler
22.6W x 17.5D x 11.8H – 2.7 cubic feet (right)
Includes: interior lighting, CLEANemail coating, one electric grill and an oven kit (one large grill, one drip pan, one porcelain roasting dish, one raised grill)

Starting from \$169,800

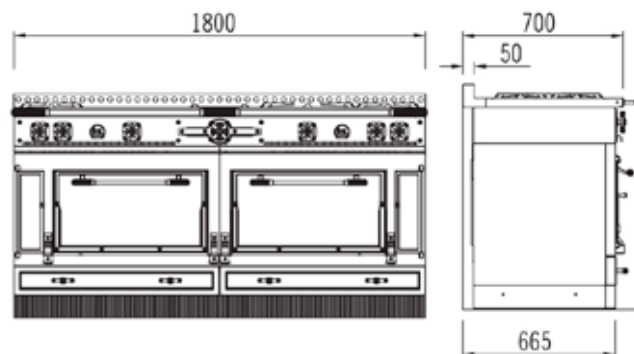

CHÂTEAU SUPRÊME GRAND PALAIS 180

CHÂTEAU SUPRÊME WARMING DRAWER

Two optional warming drawer cabinets, each featuring an electric teppanyaki top *or* stainless steel tops
Top storage drawer
False drawers open as one door with two warming drawers inside
Warming Drawer weight limit per shelf: 110 pounds
Temperature: 130°F to 240°F (*ideal for slow cooking*)

Starting from \$56,600 (Qty 2)

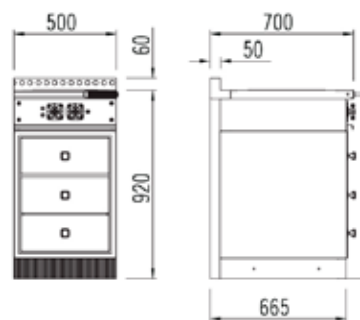

500 W x 665 D x 920 H (mm)
19.7 W x 26.2 D x 36.2 H (inches)
Approx. 200 lb. uncrated, 680 lb. crated

DETAILS EXCLUSIVE TO ALL CHÂTEAU SUPRÊME RANGES:

- Iconic La Cornue – Ferris Rafauli brand plate
- Four new Château Suprême Colors developed by Ferris Rafauli exclusively for this range, including FR Blue, Essex Green, California Blue and Cloud Gray, as well as being available in most existing Château finishes
- The Ferris Exclusive Trims are the **ONLY** trim options available on the Château Suprême Range (Polished Brass and Polished Nickel *or* Brushed Stainless Steel and Brushed Nickel)
- Burners and French Top engraved with the La Cornue stars
- Solid walnut chopping block included with all cooktop configurations featuring the Lava Rock Grill
- Designer dual-finish control knobs
- Art Deco inspired bezels and toe kick featuring individually aligned moulded bars

CHÂTEAU SUPRÊME 150

1500 W x 700 D x 914 H (mm)
59.1 W x 27.6 D x 36 H (inches)
Approx. 620 lb. uncrated, 1230 lb. crated

OPTIONS:

- Two optional warming drawer cabinets, each featuring an electric teppanyaki top **or** stainless steel tops
- Three cooktop configurations
- Château Suprême 150 hood, finished to match the range, or in an optional leather-covered exterior

OVENS:

1 Vaulted Gas Oven with Electric Broiler 16.8W x 19.8D x 11.8H – 2.3 cubic feet (left)
1 Vaulted Electric Oven with Electric Broiler 16.8W x 17.5D x 11.8H – 2.0 cubic feet (right)
Includes: interior lighting, CLEANemail coating, one electric grill and an oven kit (one large grill, one drip pan, one porcelain roasting dish, one raised grill)

Starting from \$163,500

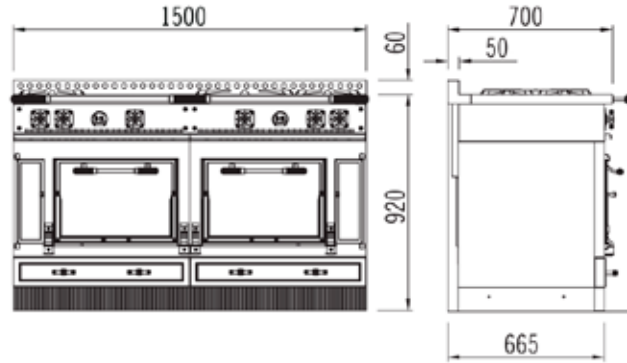

CHÂTEAU SUPRÊME 150

CHÂTEAU SUPRÊME WARMING DRAWER

Two optional warming drawer cabinets, each featuring an electric teppanyaki top **or** stainless steel tops
Top storage drawer
False drawers open as one door with two warming drawers inside
Warming Drawer weight limit per shelf: 110 pounds
Temperature: 130°F to 240°F (*ideal for slow cooking*)

Starting from \$56,600 (Qty 2)

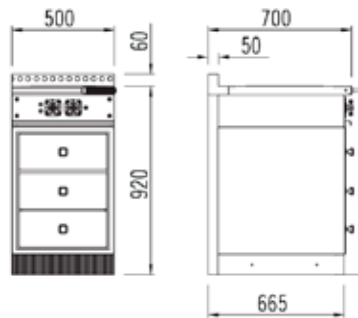

500 W x 665 D x 920 H (mm)
19.7 W x 26.2 D x 36.2 H (inches)
Approx. 200 lb. uncrated, 680 lb. crated

DETAILS EXCLUSIVE TO ALL CHÂTEAU SUPRÊME RANGES:

- Iconic La Cornue – Ferris Rafauli brand plate
- Four new Château Suprême Colors developed by Ferris Rafauli exclusively for this range, including FR Blue, Essex Green, California Blue and Cloud Gray, as well as being available in most existing Château finishes
- The Ferris Exclusive Trims are the **ONLY** trim options available on the Château Suprême Range (Polished Brass and Polished Nickel **or** Brushed Stainless Steel and Brushed Nickel)
- Burners and French Top engraved with the La Cornue stars
- Solid walnut chopping block included with all cooktop configurations featuring the Lava Rock Grill
- Designer dual-finish control knobs
- Art Deco inspired bezels and toe kick featuring individually aligned moulded bars

Château Suprême by Ferris Rafauli

CHÂTEAU SUPRÊME GRAND PALAIS 180 RANGETOP CONFIGURATIONS: G48FR



180 N1

- 2 gas burners
- 1 Large Plaque "French Top"
- 1 Power burner
- 2 gas burners



180 N1 SPE

- 2 Gas burners
- 1 Large Plaque "French Top"
- 1 Gas lava-rock grill
- 1 Power burner
- 2 Gas burners
- Walnut chopping block



180 N2

- 2 gas burners
- 1 Large Plaque "French Top"
- 1 Large electric Teppanyaki
- 2 Induction Plates



180 N2 SPE

- 2 Gas burners
- 1 Large Plaque "French Top"
- 1 Gas lava-rock grill
- 1 Large electric Teppanyaki
- 2 Induction Plates
- Walnut chopping block



180 NM

- 2 gas burners
- 1 Large Plaque "French Top"
- 1 Power burner
- 2 Induction Plates



180 NM SPE

- 2 gas burners
- 1 Large Plaque "French Top"
- 1 Gas lava-rock grill
- 1 Power burner
- 2 Induction Plates
- Walnut chopping block

CHÂTEAU SUPRÊME 150 RANGETOP CONFIGURATIONS: G45FR



150 K1

- 2 Gas burners
- 1 Large Plaque "French Top"
- 1 Power burner
- 2 Gas burners



150 K2

- 2 Gas burners
- 1 Large Plaque "French Top"
- 1 Large electric Teppanyaki
- 2 Induction Plates



150 KM

- 2 Gas burners
- 1 Large Plaque "French Top"
- 1 power burner
- 2 Induction Plates

CHÂTEAU SUPRÊME HOODS:

CHÂTEAU SUPRÊME HOOD 180

- 2000 W x 650 D x 1565 H (mm)
- 78.7 W x 25.6 D x 61.6 H (inches)
- Weight: 728 lbs
- 6 Baffle Filters
- 6 LED Lights
- 1200 CFM Internal Blower
- Starting from \$58,400

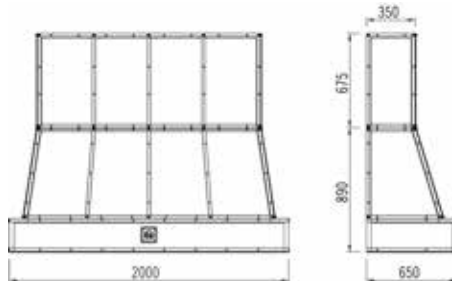

CHÂTEAU SUPRÊME 180 HOOD

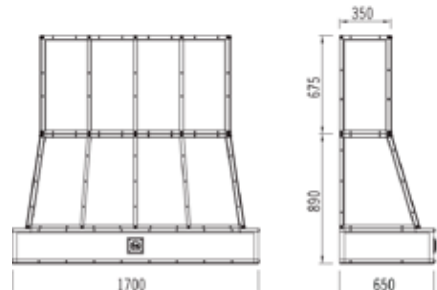

CHÂTEAU SUPRÊME 150 HOOD

CHÂTEAU SUPRÊME HOOD 150

- 1700 W x 650 D x 1565 H (mm)
- 66.9 W x 25.6 D x 61.6 H (inches)
- Weight: 684 lbs
- 3 Baffle Filters
- 5 LED Lights
- 1200 CFM Internal Blower
- Starting from \$52,100

CornuFé Series

In 2005, the CornuFé Series was born, introducing La Cornue to a whole new generation. For those who hate to wait, units are inventoried stateside, and are available in sixteen colors with three trim combinations. Designed with the American kitchen in mind, the CornuFé Series features electric multi-function convection ovens and either robust brass burners or induction.

CORNUFÉ 110: c1

1092 W x 650 D x 910 (937 max) H (mm)
43 W x 25.6 D x 35.8 (36.9 max) H (inches)
350 lb. uncrated, 465 lb. crated
High-performance 5 burner gas cooktop
Double electric convection ovens
Classic Color Retail: \$13,275
Suzanne Kasler Color Collection Retail: \$13,995
Designer Color Retail: \$13,995

SPECIFICATIONS:

Gas Burners:

1 17,500 BTU Central Burner
3 12,000 BTU Burners
1 6,000 BTU Simmer Burner
Solid Brass Burners Enamel-Capped with Thermocouple Safety Mechanism

Ovens:

French side-swing enameled steel doors
2 Electric Convection Ovens, one of which features 7 cooking modes
4 Interior Oven Racks Included (2 flat racks, 2 dropped racks)
2 Enamel Baking Trays and 1 Trivet
Left Oven: 430 W x 370 D x 380 H (mm)
16.9 W x 14.6 D x 15 H (inches)
2.2 cubic feet
Right Oven: 430 W x 370 D x 410 H (mm)
16.9 W x 14.6 D x 16.2 H (inches)
2.39 cubic feet

Range Accessories: Plaque Adaptor Kit, Wok Ring,
Grill/Griddle Plate

Power and Fuel:

Voltage: 240v; 60Hz, 21 AMP
Gas connection: 1/2 inch NPT at rear right-hand side
Natural gas range with propane conversion kit included
High-Altitude Kit required for elevations above 5,000 feet
Natural Gas High-Altitude Kit "A037977": Retail for \$65
Propane High-Altitude Kit "A037982": Retail for \$65

Available Finishes:

Classic Colors: Matte Black, Stainless Steel, Gloss Black,
and Pure White

Designer Colors: Morning Dew, Graphite, Ocean, and Wintersky

Retiring Colors: Ivory, Dark Navy Blue, Royal Blue, Provence Blue,
*Suzanne Kasler Color Collection Colors: Liberte,
Blanc, Tapestry and Roquefort
(Available for Order until June of 2023)*

Three Trim Options: Stainless Steel Trim and Rail with
Satin Chrome Accents

Stainless Steel Trim with Polished Brass Rail
and Accents

Stainless Steel Trim, Polished Stainless Steel Rail,
with Polished Chrome Accents

NOTE: Side panels are stainless steel for all colors except Gloss Black, Matte Black
and Dark Navy Blue ranges have flat black side panels. The Polished Brass Trim is
natural, non coated metal and will patina over time.

For coordinating hoods, please see Page 24.

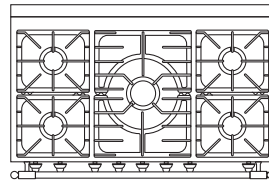
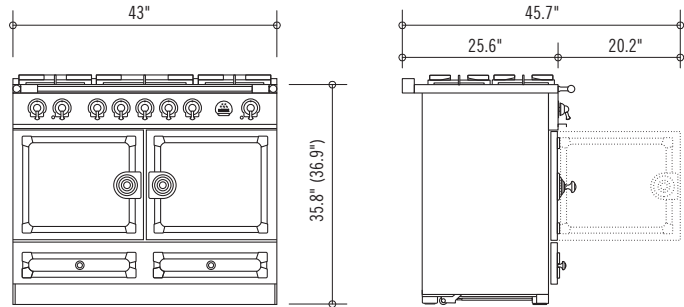

CORNUFÉ 110 INDUCTION: c1-i

1092 W x 720 D x 915 (942 max) H (mm)
43 W x 28.6 D x 36.3 (36.9 max) H (inches)
350 lb. uncrated 465 lb. crated
High-performance 5 zone induction cooktop
Double electric convection ovens
Classic Color Retail: \$14,875
Suzanne Kasler Color Collection Retail: \$15,675
Designer Color Retail: \$15,675

SPECIFICATIONS:

Induction Cooktop ratings:

Front Left: 1.4 kW (Max) 2.2 kW (Boost)
Rear Left: 1.85 kW (Max) 3.0 kW (Boost)
Center: 2.3 kW (Max) 3.7 kW (Boost)
Front Right: 1.85 kW (Max) 3.0 kW (Boost)
Rear Right: 1.85 kW (Max) 3.0 kW (Boost)

Ovens:

French side-swing enameled steel doors
2 Electric Convection Ovens, one of which features 7 cooking modes
4 Interior Oven Racks Included (2 flat racks, 2 dropped racks)
2 Enamel Baking Trays and 1 Trivet
Left Oven: 430 W x 370 D x 380 H (mm)
16.9 W x 14.6 D x 15 H (inches)
2.2 cubic feet
Right Oven: 430 W x 370 D x 410 H (mm)
16.9 W x 14.6 D x 16.2 H (inches)
2.39 cubic feet

Power and Fuel:

Voltage: 240v; 60Hz, 50 AMP

Available Finishes:

Classic Colors: Matte Black, Stainless Steel, Gloss Black, and Pure White

Designer Colors: Morning Dew, Graphite, Ocean, and Wintersky

Retiring Colors: Ivory, Dark Navy Blue, Royal Blue, Provence Blue,
Suzanne Kasler Color Collection Colors: Liberte, Blanc, Tapestry and Roquefort
(Available for Order until June of 2023)

Three Trim Options: Stainless Steel Trim and Rail with
Satin Chrome Accents

Stainless Steel Trim with Polished Brass Rail
and Accents

Stainless Steel Trim, Polished Stainless Steel Rail,
with Polished Chrome Accents

NOTE: Side panels are stainless steel for all colors except Gloss Black, Matte Black and Dark Navy Blue ranges have flat black side panels. The Polished Brass Trim is natural, non coated metal and will patina over time.

For coordinating hoods, please see Page 24.

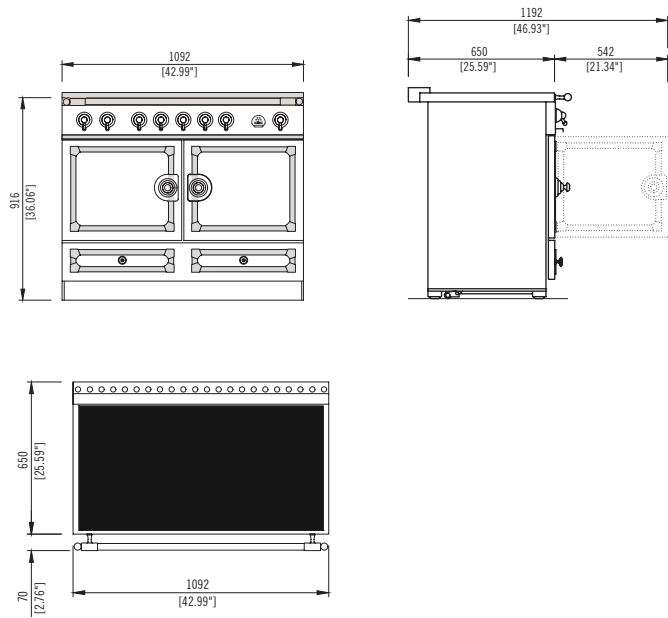

CORNUFÉ 90 “ALBERTINE”[®] C9

900 W x 650 D x 910 (937 max) H (mm)
35.4 W x 25.6 D x 35.8 (36.9 max) H (inches)
315 lb. uncrated, 410 lb. crated
High-performance 5 burner gas cooktop
Large electric convection oven
Classic Color Retail: \$10,775
Suzanne Kasler Color Collection Retail: \$11,495
Designer Color Retail: \$11,495

SPECIFICATIONS:

Gas Burners:

1 17,500 BTU Central Burner
3 12,000 BTU Burners
1 6,000 BTU Simmer Burner
Solid Brass Enamel-Capped Burners with Thermocouple
Safety Mechanism

Oven:

Enameled steel door with glass inner door
Electric convection oven featuring 7 cooking modes
2 Convection Fans, 8 Heating Elements
1 Wire Rack
1 Large Tray Equipped with Broil Pan
1 Pastry Tray
1 Telescopic Rack
714 W x 389 D x 381 H (mm)
28.1 W x 15.3 D x 15 H (inches)
3.81 cubic feet

Power and Fuel:

Voltage: 240v; 60Hz, 16 AMP
Gas connection: 1/2 inch NPT at rear left-hand side
Natural gas range with propane conversion kit included
High-Altitude Kit required for elevations above 5,000 feet
Natural Gas High-Altitude Kit “A037977”: Retail for \$65
Propane High-Altitude Kit “A037982”: Retail for \$65

Available Finishes:

Classic Colors: Matte Black, Stainless Steel, Gloss Black,
and Pure White

Designer Colors: Morning Dew, Graphite, Ocean, and Wintersky

Retiring Colors: Ivory, Dark Navy Blue, Royal Blue, Provence
Blue, *Suzanne Kasler Color Collection Colors:*
Liberte, Blanc, Tapestry and Roquefort
(Available for Order until June of 2023)

Three Trim Options: Stainless Steel Trim and Rail with
Satin Chrome Accents

Stainless Steel Trim with Polished Brass Rail
and Accents

Stainless Steel Trim, Polished Stainless Steel
Rail, with Polished Chrome Accents

NOTE: Side panels are stainless steel for all colors except Gloss Black, Matte
Black and Dark Navy Blue ranges have flat black side panels. The Polished
Brass Trim is natural, non coated metal and will patina over time.

For coordinating hoods, please see Page 24.

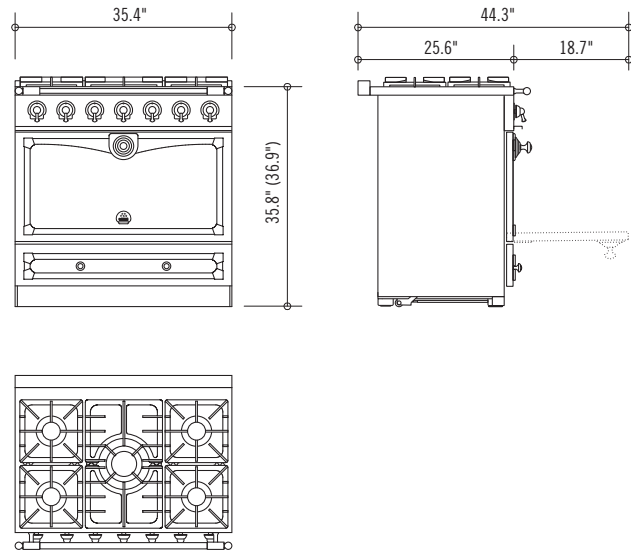

CORNUFÉ 90 “ALBERTINE” INDUCTION: c9-1

900 W x 711 D x 911 (936 max) H (mm)
35.4 W x 28 D x 35.8 (36.9 max) H (inches)
315 lb uncrated, 410 lb Crated
High-performance 5 zone induction cooktop
Large electric convection oven
Classic Color Retail: \$12,075
Suzanne Kasler Color Collection Retail: \$12,875
Designer Color Retail: \$12,875

SPECIFICATIONS:

Induction Cooktop ratings:

Front Left: 1.4 kW (Max) 2.2 kW (Boost)

Rear Left: 1.85 kW (Max) 3.0 kW (Boost)

Center: 2.3 kW (Max) 3.7 kW (Boost)

Front Right: 1.85 kW (Max) 3.0 kW (Boost)

Rear Right: 1.85 kW (Max) 3.0 kW (Boost)

Note: Front Right and Rear Right Burners can be bridged

Oven:

Enameled steel door with glass inner door

Electric convection oven featuring 7 cooking modes

2 Convection Fans, 8 Heating Elements

1 Deluxe oven tray

1 Large Tray Equipped with Broil Pan

1 Pastry Tray

2 Telescopic Racks

714 W x 389 D x 381 H (mm)

28.1 W x 15.3 D x 15 H (inches)

3.81 cubic feet

Power and Fuel:

Voltage: 240v; 60Hz, 50 AMP

Available Finishes:

Classic Colors: Matte Black, Stainless Steel, Gloss Black,
and Pure White

Designer Colors: Morning Dew, Graphite, Ocean, and Wintersky

Retiring Colors: Ivory, Dark Navy Blue, Royal Blue, Provence
Blue, *Suzanne Kasler Color Collection Colors:*
Liberte, Blanc, Tapestry and Roquefort
(Available for Order until June of 2023)

Three Trim Options: Stainless Steel Trim and Rail with
Satin Chrome Accents

Stainless Steel Trim with Polished Brass Rail
and Accents

Stainless Steel Trim, Polished Stainless Steel
Rail, with Polished Chrome Accents

NOTE: Side panels are stainless steel for all colors except Gloss Black, Matte
Black and Dark Navy Blue ranges have flat black side panels. The Polished
Brass Trim is natural, non coated metal and will patina over time.

For coordinating hoods, please see Page 24.

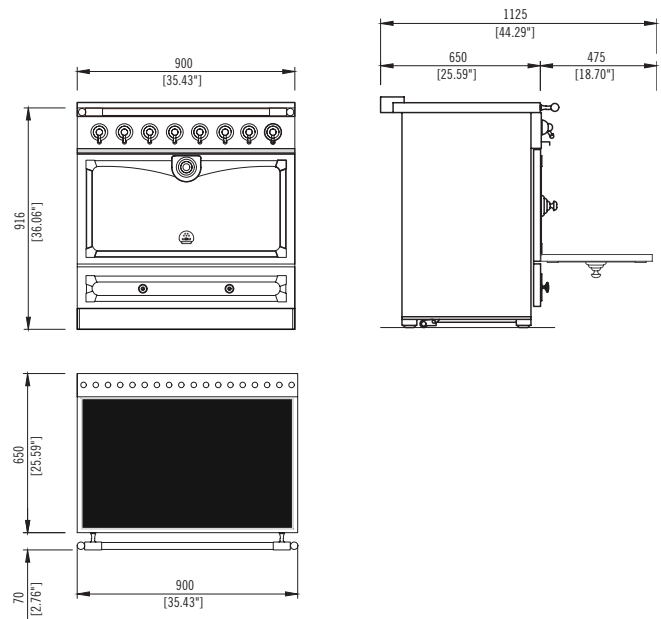

CORNUFÉ 90 HOOD: H9

900 W x 650 D x 700 H (mm)
 35.4 W x 25.6 D x 27.5 H (inches)
 Traditional wall-mounted chimney hood
 Available in all color and trim options
 4-Speed Variable Motor
 One 600 CFM blower – unobstructed air flow with Ø6" duct
 Remote Control and In-Hood Activation Controls
 Three 20W high-intensity lights
 2 dishwasher-safe baffle filters with grease capture system
 Voltage: 120v; 60Hz, total rating: 425W, 3.6 AMP
 Telescopic flue cover extends to maximum hood height of 39.37" (1000 mm)

Classic Color Retail: \$6,075
 Suzanne Kasler Color Collection Retail: \$6,575
 Designer Color Retail: \$6,575

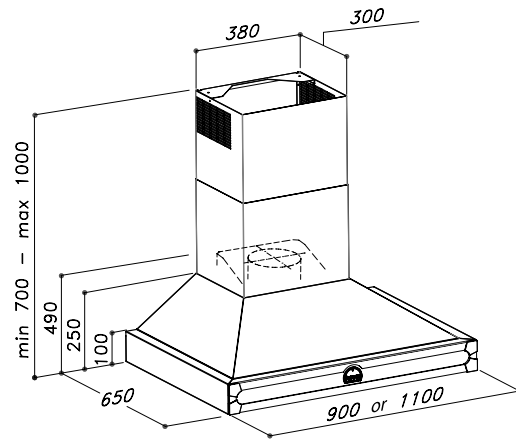

CORNUFÉ 110 HOOD: H1

1100 W x 650 D x 700 H (mm)
 43.3 W x 25.6 D x 27.5 H (inches)
 Traditional wall-mounted chimney hood
 Available in all color and trim options
 4-Speed Variable Motor
 One 600 CFM blower – unobstructed air flow with Ø6" duct
 Remote Control and In-Hood Activation Controls
 Three 20W high-intensity Halogen lights
 2 dishwasher-safe baffle filters with grease capture system
 Voltage: 120v; 60Hz, total rating: 425W, 3.6 AMP
 Telescopic flue cover extends to maximum hood height of 39.37" (1000 mm)

Classic Color Retail: \$6,225
 Suzanne Kasler Color Collection Retail: \$6,675
 Designer Color Retail: \$6,675

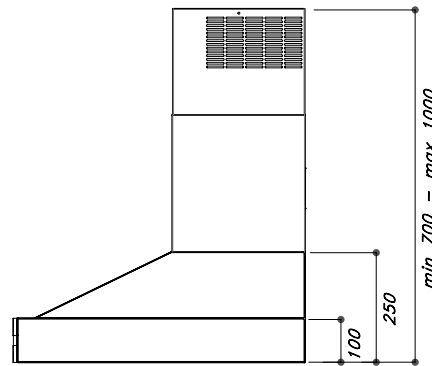

CORNUFÉ HOOD INSERTS

In 2020, La Cornue introduced hood inserts that are available for both ranges in the CornuFé Series. All CornuFé inserts include an internal blower, baffle filters, LED lights, remote control, and 3 speed touch buttons for fan and light control. Please note: The CornuFé inserts are designed for use in custom hoods and are NOT compatible with CornuFé hoods. The CornuFé inserts are inventoried and available for immediate sale.

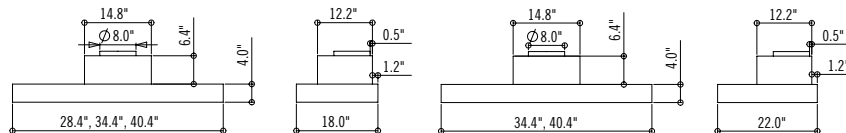

CornuFé Hood Insert: 110LC118

Compatible with C1
 40 3/8" w x 18" d Grade 304 Stainless Steel Hood Insert
 Lights: 2 LED
 Filters: Baffle
 Internal Blower: 600 CFM
 Duct Size: 8"
 Remote Control: Yes
 Approx Weight: 43 lbs
Retail: \$1,250

CornuFé Hood Insert: 110LC122

Compatible with C1
 40 3/8" w x 22" d Grade 304 Stainless Steel Hood Insert
 Lights: 2 LED
 Filters: Baffle
 Internal Blower: 600 CFM
 Duct Size: 8"
 Remote Control: Yes
 Approx Weight: 49 lbs
Retail: \$1,500

CornuFé Hood Insert: 90LC118

Compatible with C9
 34 3/8" w x 18" d Grade 304 Stainless Steel Hood Insert
 Lights: 2 LED
 Filters: Baffle
 Internal Blower: 600 CFM
 Duct Size: 8"
 Remote Control: Yes
 Approx Weight: 40 lbs
Retail: \$1,200

CornuFé Hood Insert: 90LC122

Compatible with C9
 34 3/8" w x 22" d Grade 304 Stainless Steel Hood Insert
 Lights: 2 LED
 Filters: Baffle
 Internal Blower: 600 CFM
 Duct Size: 8"
 Remote Control: Yes
 Approx Weight: 46 lbs
Retail: \$1,450

CornuFé Series Details & Accessories

CLASSIC COLORS

N	Matte Black
M	Gloss Black
I	Stainless Steel
W	Pure White

DESIGNER COLORS

P	Morning Dew
G	Graphite
O	Ocean
H	Wintersky

RETIRING COLORS (Available until June 2023)

V	Ivory
D	Dark Navy Blue
R	Royal Blue
L	Provence Blue

SUZANNE KASLER COLOR COLLECTION (Available until June 2023)

T	Liberte (Special order)
C	Blanc
A	Tapestry
Q	Roquefort

TRIM OPTIONS

	Trim	Accents	Rails
N	Stainless Steel	Satin Chrome	Stainless Steel
F	Stainless Steel	Polished Brass	Polished Brass
P	Stainless Steel	Polished Chrome	Polished Stainless Steel

Note: The Polished Brass Trim is natural, non coated metal and will patina over time.

ACCESSORIES (AVAILABLE FOR 110 AND 90):

Part Number	Description	Price
CFEBPLATE	French Plaque for CornuFé 110 Dual Fuel Ranges	\$1,550
CFEBPLATE90	French Plaque for CornuFé 90 Dual Fuel Ranges	\$1,550
CFEGRIDDLE	Grill/Griddle Plate for all CornuFé Dual Fuel Ranges	\$775
P050553	Wok Adapter for all CornuFé Dual Fuel Ranges	\$230
A037977	High Altitude Kit - Natural Gas for all CornuFé Dual Fuel Ranges	\$65
A037982	High Altitude Kit - Propane for all CornuFé Dual Fuel Ranges	\$65
09KIRSIR01	Recirculating kit for CornuFé Hood	\$450
P030292	CornuFé 110 Extra Flat Rack	\$100
CFDF5BB	CornuFé Dual Fuel 5 Brass Burner Accessory Kit	\$725

Please confirm inventory status at time of order.

Rôtisserie

The Flamberge Rôtisserie is a wall-mounted gas rôtisserie designed for residential use. Constructed with a concave rear wall of solid cast iron, it is heated by a powerful gas burner set beneath three motorized spits. Synthetic wicks pull the heat up through the vaulted back of the unit, allowing the radiant heat to gently cook foods as they rotate slowly on a spit over the flame.

FLAMBERGE RÔTISSERIE: BFG

Unit Dimensions: 755 W x 380 D x 725 H (mm)
29.7 W x 15 D x 28.5 H (inches)

Minimum Cutout Dimensions: 760 W x 457 D x 730 H (mm)
30 W x 18 D x 28.7 H (inches)

Dimensions of Metal Trim Frame: 815 W x 792 H (mm)
32 W x 31.2 H (inches)

Crated Weight: 330 lbs; Uncrated Weight: 132 lbs

Voltage: 120v

Available in gas only (Natural or Propane)

Gas – 27,000 BTU Natural or 25,000 BTU Propane

Accessories Included:

2 Metal Spits

1 Fish Basket

1 Porcelain Enamel Drip Tray

Starting from \$16,400

Please note: The Centenary Rôtisserie is a UL-Approved product for residential installation. A gravity flue is not *required* but may be used as desired. This is a zero clearance product.

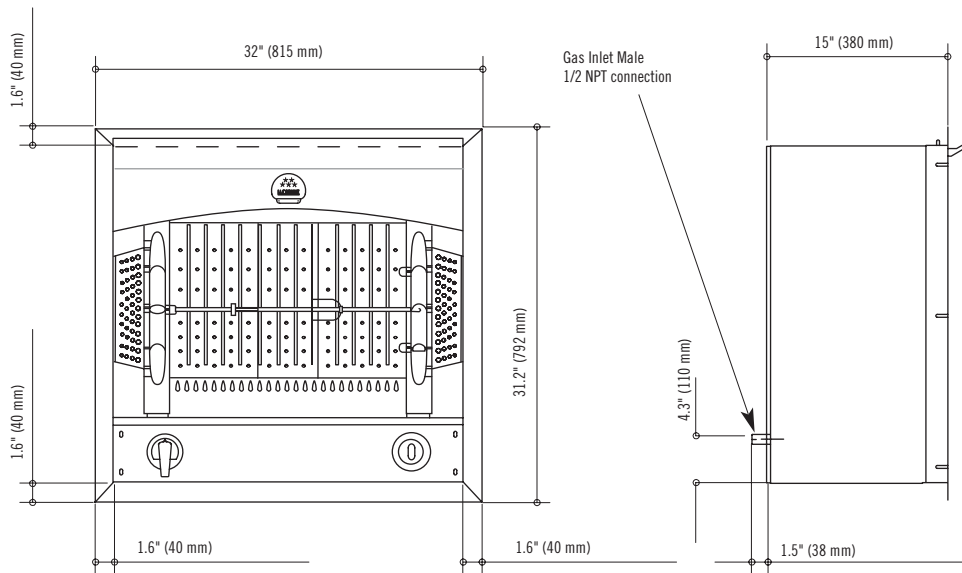

La Cornue Accessories & Options

La Cornue offers a variety of accessories to complement our ranges, as well as some options for items which complement the La Cornue cooking experience. Alternative finishes are also available for specific design aesthetics.

POTRACKS: POT

2 solid metal brackets and 1 metal potrack bar, equipped with 5 solid metal hooks. 1800 mm length is supplied with 3 brackets and 8 hooks. Wall-mounted. Additional metal hooks available with purchase. Pots are not included.

Length (mm)	(inches)	Brushed or Polished Brass	Brushed Nickel, Polished Chrome, Black Shiny Chrome or Matte Black	Brushed or Polished Copper or Matte Bronze
750	29.5	\$3,800	\$4,370	\$4,940
900	35.4	\$4,100	\$4,715	\$5,330
1200	47.2	\$4,600	\$5,290	\$5,980
1500	59.1	\$5,300	\$6,095	\$6,890
1650	65.0	\$5,400	\$6,210	\$7,020
1800	70.9	\$5,700	\$6,555	\$7,410

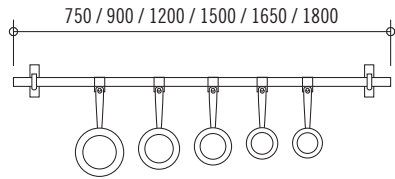

RATELIER: RAT

Solid Dark Walnut or Light Oak shelf nests atop 2 black cast aluminum brackets, which serve as support for solid metal potrack bar with 5 solid metal hooks. Wall-mounted. Additional metal hooks available with purchase. Pots are not included.

Length (mm)	(inches)	Brushed or Polished Brass	Brushed Nickel, Polished Chrome, Black Shiny Chrome or Matte Black	Brushed or Polished Copper or Matte Bronze
800 / 900 / 1000	31.5 / 35.4 / 39.4	\$5,700	\$6,555	\$7,410
1200	47.2	\$6,500	\$7,475	\$8,450
1400	55.1	\$7,100	\$8,165	\$9,230

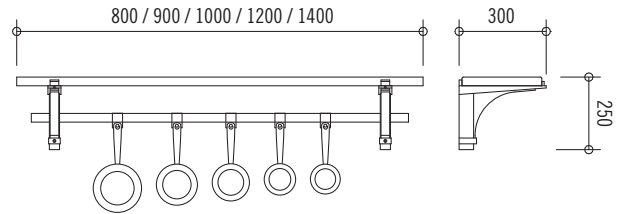

ETAGER: ETA

Solid Dark Walnut or Light Oak shelf nests atop 2 black cast aluminum brackets. Wall-mounted.

Length (mm)	(inches)	
800 / 900 / 1000	31.5 / 35.4 / 39.4	\$2,900
1200	47.2	\$3,100
1400	55.1	\$3,400

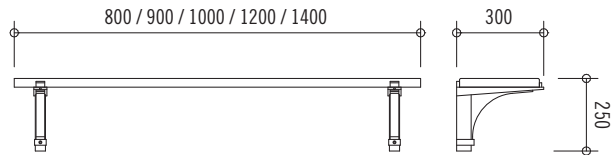

Cuisine de Château Cabinetry

All cabinetry comes open framed; countertops are not included. Stainless Steel countertops are available to quote. Unfinished Stainless Steel side and back panels are available at no extra charge. Finished enamel or finished Stainless Steel panels are available for an additional cost (see page 28). All drawers come with a standard rubber drawer liner. False drawers (decorative trim applied to exterior of non-functioning cabinet panel) can be made into working drawers for an additional cost. Additional customization available to quote.

*Note: All Château Drawer Cabinets may be used as a sink base; when used in this application, please note that the large top drawer or top two small drawers will not be functional. A shelf may be possible dependent on the sink specified. **Porte Cabinets:** Select cabinets from the Porte series are open bottom to allow for compatibility with dishwashers, sinks, variors or other custom applications. Any Porte cabinet can be ordered with a Stainless Steel bottom, back or side. [These include PT4, POT, PT4, POM, POP] All Château Cabinetry height can be adjusted .5" plus or minus*

PORTE TECHNIQUE 400: PT4

400 W x 665 D x 891 H (mm)
 15.7 W x 26.2 D x 35.0 H (inches)
 1 Large Door, Left- or Right-hand Hinged
 1 False Drawer
 Drawer may be made functional for additional cost
 Supplied without a shelf or base
 Open bottom with 2 Stainless Steel inner sides and back
 Shelf may be added: ETS Middle Shelf \$600 or ETB Bottom Shelf \$600
 Starting from \$11,100

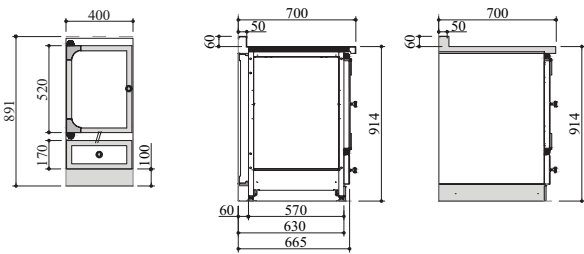

PORTE TECHNIQUE 500: POT

500 W x 665 D x 891 H (mm)
 19.7 W x 26.2 D x 35.0 H (inches)
 1 Large Door, Left- or Right-hand Hinged
 1 False Drawer
 Supplied without a shelf or base
 Open bottom with 2 Stainless Steel inner sides and back
 Shelf may be added: ETS Middle Shelf \$600 or ETB Bottom Shelf \$600
 Starting from \$11,200

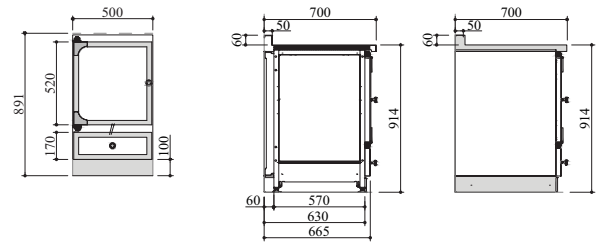

PORTE SIMPLE 500: POS

500 W x 665 D x 891 H (mm)
 19.7 W x 26.2 D x 35.0 H (inches)
 1 Door, Left- or Right-hand Hinged
 1 Adjustable Shelf (3 Positions)
 2 Stainless Steel inner sides and back
 1 Drawer
 Starting from \$12,200

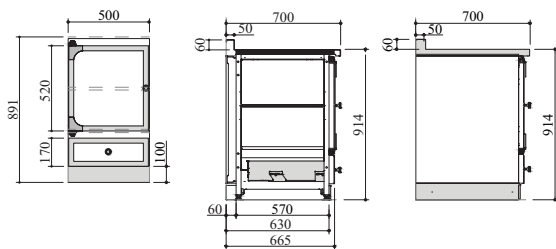

MEUBLE POUBELLE (WASTE BIN) 500 - TOP: BIN

500 W x 665 D x 891 H (mm)
 19.7 W x 26.2 D x 35.0 H (inches)
 1 Top Waste Bin
 1 Drawer
 Two 28L Waste Bins sold separately — \$1000 (see page 35)
 Starting from \$11,900

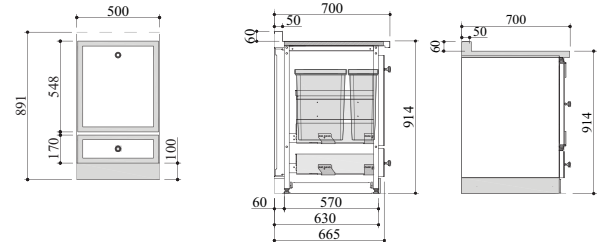

PORTE TECHNIQUE MACHINE 550: POP

550 W x 665 D x 891 H (mm)
 21.7 W x 26.2 D x 35.0 H (inches)
 1 Door, Left- or Right-hand Hinged
 1 Large Door with False Drawer
 False Drawer may be fixed so that only door portion opens
 Specialty housing unit designed for interior customization
 Open bottom unit compatible for use with some dishwashers, sinks, varios, etc.
 Designed to accommodate appliance up to 45 cm/ 17.7" wide
 Open bottom with 2 Stainless Steel inner sides and open back
 Shelf may be added: ETS Middle Shelf \$700 or ETB Bottom Shelf \$800
 Starting from \$11,600

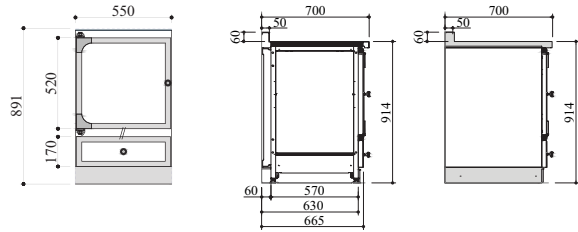

PORTE TECHNIQUE 600: PT6

600 W x 665 D x 891 H (mm)
 23.6 W x 26.2 D x 35.0 H (inches)
 1 Large Door, Left- or Right-hand Hinged
 1 False Drawer
 Supplied without Shelf or Base
 Open bottom with 2 Stainless Steel sides and back
 Shelf may be added: ETS Middle Shelf \$800 or ETB Bottom Shelf \$900
 Starting from \$11,900

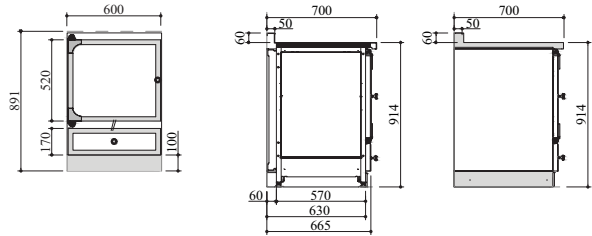

PORTE SIMPLE 600: PS6

600 W x 665 D x 891 H (mm)
 23.6 W x 26.2 D x 35.0 H (inches)
 1 Door, Left- or Right-hand Hinged
 1 Adjustable Shelf (3 Positions)
 1 Drawer
 Starting from \$12,500

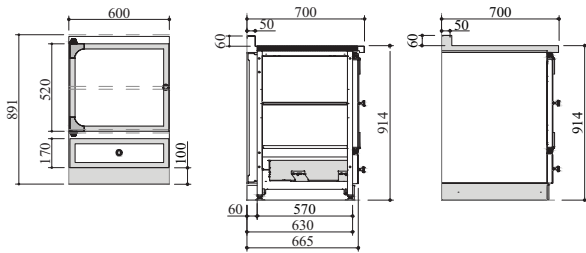

MEUBLE POUBELLE (WASTE BIN) 600 - TOP: BIM

600 W x 665 D x 891 H (mm)
 23.6 W x 26.2 D x 35.0 H (inches)
 1 Top Waste Bin
 1 Drawer
 Two 28L Waste Bins and one 8.5L: Bin sold separately — \$1,500 (see page 35)
 Starting from \$12,400

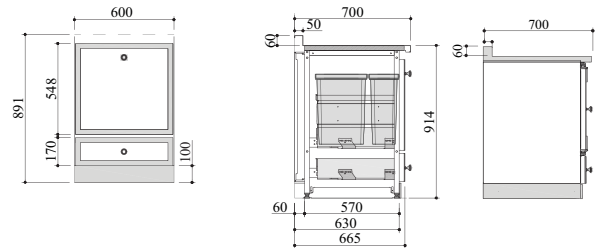

DISHWASHER FAÇADE 610: HLV

610 W x 885 H (mm)
 24 W x 34.8 H (inches)
 Single panel mounted to front of dishwasher
 Compatible with Viking VKFDWU524 Dishwasher
 Must be installed between cabinets
 Panel comprised of enameled steel façade with frame and knob, Stainless
 Steel plinth (replaces original) and adaptor for attachment to countertop
 Panel weight: 26.5 lbs (12 kg)
 Starting from \$6,300

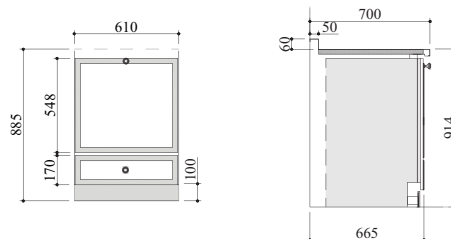

PORTE TECHNIQUE MACHINE 700: P0M

700 W x 665 D x 891 H (mm)
 27.6 W x 26.2 D x 35.0 H (inches)
 1 Door, Left- or Right-hand Hinged
 1 Large Door with False Drawer
 False Drawer may be fixed so that only door portion opens
 Designed to accommodate appliance up to 60 cm/ 23.6' wide
 Open bottom with 2 Stainless Steel inner sides and open back
 Shelf may be added: ETS Middle Shelf \$800 or ETB Bottom Shelf \$900
 Specialty housing unit designed for interior customization.
 Open bottom unit compatible for use with some dishwashers, sinks, varios, etc.
 Starting from \$12,500

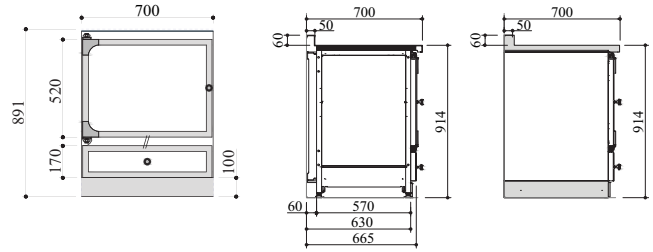

MEUBLE POUBELLE (WASTE BIN) 800 - TOP: B18

800 W x 665 D x 891 H (mm)
 31.5 W x 26.2 D x 35.0 H (inches)
 1 Top Waste Bin
 1 Drawer
 One 39L Waste Bin and two 28L Waste Bins sold separately — \$2,000 (see page 35)
 Starting from \$14,900

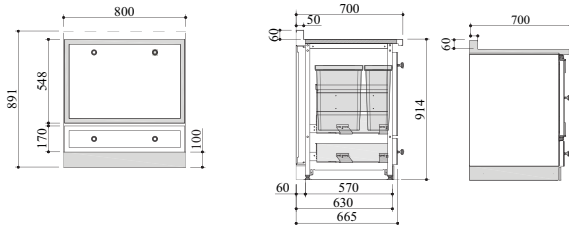

PORTE TECHNIQUE DOUBLE 900: PT9

900 W x 665 D x 891 H (mm)
 35.5 W x 26.2 D x 35.0 H (inches)
 2 Doors with Center Divider and False Drawers
 Shelf may be added: ETS Middle Shelf \$1,000 or ETB Bottom Shelf \$1,300
 Stainless Steel inner sides and back
 Starting from \$18,000

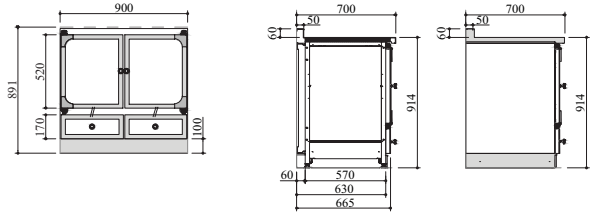

PORTE DOUBLE 900: P09

900 W x 665 D x 891 H (mm)
 35.5 W x 26.2 D x 35.0 H (inches)
 2 Doors with a Center Divider
 1 Adjustable Shelf (3 Positions)
 2 Drawers
 Stainless Steel inner sides and back
 Starting from \$19,300

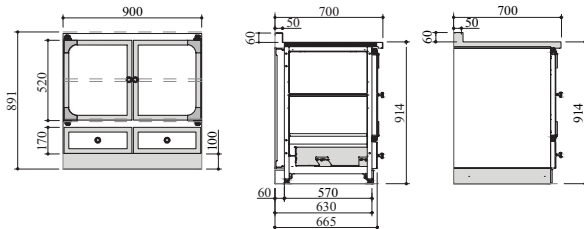

PORTE DOUBLE 1000: P0D

1000 W x 665 D x 891 H (mm)
 39.4 W x 26.2 D x 35.0 H (inches)
 2 Doors with a Center Divider
 1 Adjustable Shelf (3 Positions)
 2 Drawers
 Stainless Steel inner sides and back
 Starting from \$19,800

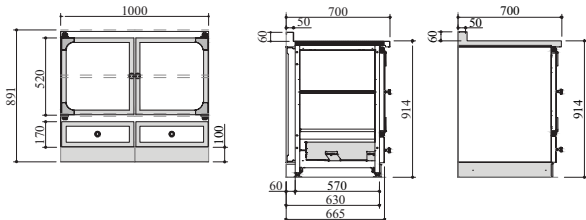

PORTE TECHNIQUE DOUBLE 1000: PTD

1000 W x 665 D x 891 H (mm)
 39.4 W x 26.2 D x 35.0 H (inches)
 2 Doors with Center Divider and False Drawers
 Shelf may be added: ETS Middle Shelf \$1,000 or ETB Bottom Shelf \$1,300
 Stainless Steel inner sides and back
 Starting from \$18,500

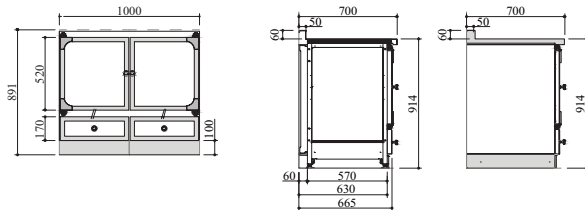

PORTE DOUBLE 1200: P0B

1200 W x 665 D x 891 H (mm)
 47.2 W x 26.2 D x 35.0 H (inches)
 2 Doors with a Center Divider
 1 Adjustable Shelf (3 Positions)
 Stainless Steel inner sides and back
 2 Drawers
 Starting from \$20,900

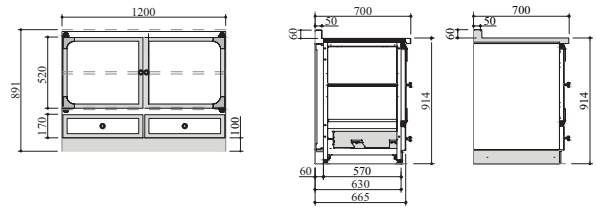

EPICERIE HUILERIE 250: EPH

250 W x 665 D x 891 H (mm)
 9.8 W x 26.2 D x 35.0 H (inches)
 "Spice and Oil Cabinet" made of Solid Dark Walnut or Light Oak
 1st Drawer will contain a spice rack with a stainless finished bottom
 2nd Drawer will have a stainless finished bottom
 3rd Drawer will have a stainless finished bottom for tall bottles and oils
 Walnut starting from \$13,600
 Oak starting from \$11,400

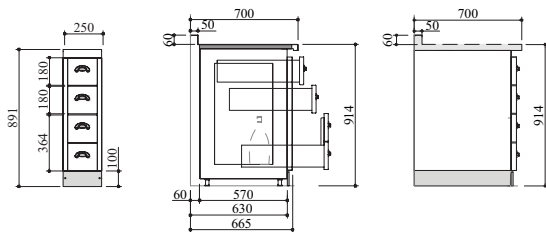

EPICERIE 250: EPI

250 W x 665 D x 891 H (mm)
 9.8 W x 26.2 D x 35.0 H (inches)
 1st Drawer will contain a spice rack with a stainless finished bottom
 2nd Drawer will have three removable containers with lids and a stainless finished bottom
 3rd Drawer will have two removable containers with lids and a stainless finished bottom
 4th Drawer will have a stainless finished bottom
 Walnut starting from \$14,900
 Oak starting from \$12,000

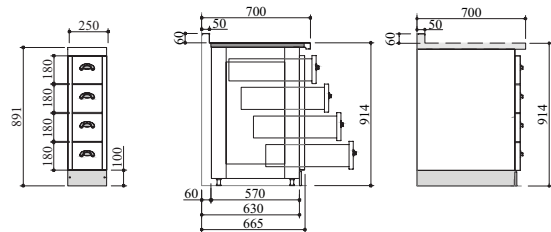

TIROIR 500: TIR

500 W x 665 D x 891 H (mm)
 19.7 W x 26.2 D x 35.0 H (inches)
 4 Small Drawers
 Rubber liner bottoms in each drawer
 Starting from \$13,900

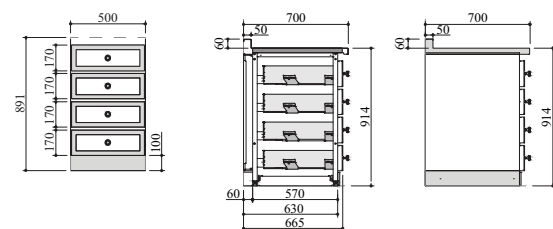

MEUBLE POUBELLE (WASTE BIN) 500 - BOTTOM: TIN

500 W x 665 D x 891 H (mm)
 19.7 W x 26.2 D x 35.0 H (inches)
 1 Small Top Drawer
 1 Large Bottom Waste Bin
 Rubber liner provided in top drawer
 Two 28 L Waste Bins sold separately — \$1,000 (see page 35)
 Starting from \$12,500

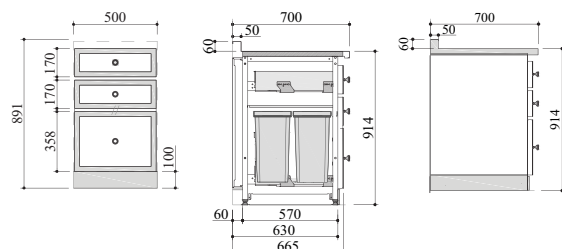

PETITE CASSEROLIERIE 500: TPC

500 W x 665 D x 891 H (mm)
19.7 W x 26.2 D x 35.0 H (inches)
2 Small Drawers
1 Large Drawer
Rubber liner bottoms in each drawer
Starting from \$12,600

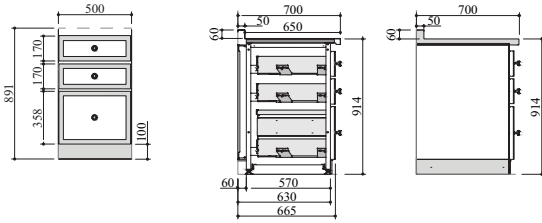

GRANDE CASSEROLIERIE 500: T6C

500 W x 665 D x 891 H (mm)
19.7 W x 26.2 D x 35.0 H (inches)
2 Large Drawers
Rubber liner bottoms in each drawer
Starting from \$11,900

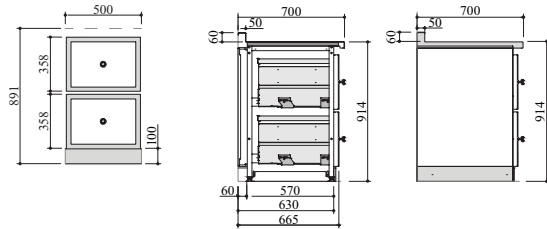

MAXI TIROIR 600: TMT

600 W x 665 D x 891 H (mm)
23.6 W x 26.2 D x 35.0 H (inches)
4 Small Drawers
Rubber liner bottoms in each drawer
Starting from \$15,100

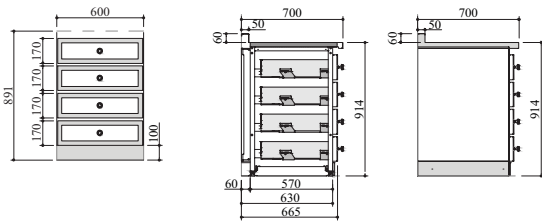

MAXI RANGEMENT 600: TMR

600 W x 665 D x 891 H (mm)
23.6 W x 26.2 D x 35.0 H (inches)
2 Small Drawers
1 Large Drawer
Rubber liner bottoms in each drawer
Starting from \$12,900

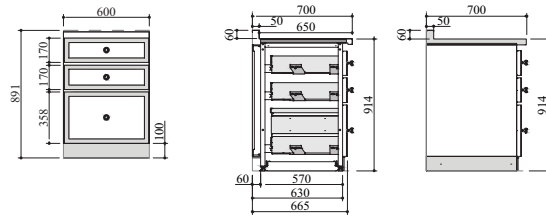

MEUBLE POUBELLE (WASTE BIN) 600 - BOTTOM: TMB

600 W x 665 D x 891 H (mm)
23.6 W x 26.2 D x 35.0 H (inches)
1 Small Top Drawer
1 Large Bottom Waste Bin
Top drawer can be a "false drawer" to accommodate a sink
Two 28L Waste Bins and one 8.5L Bin sold separately — \$1,500 (see page 35)
Starting from \$12,800

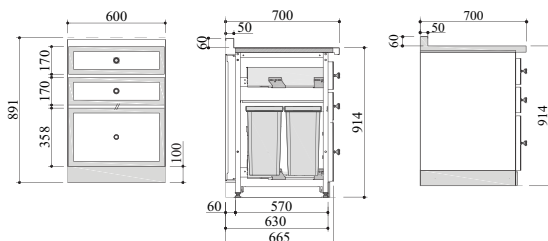

MAXI CASSEROLIERIE 600: TMC

600 W x 665 D x 891 H (mm)
23.6 W x 26.2 D x 35.0 H (inches)
2 Large Drawers
Rubber liner bottoms in each drawer
Starting from \$12,200

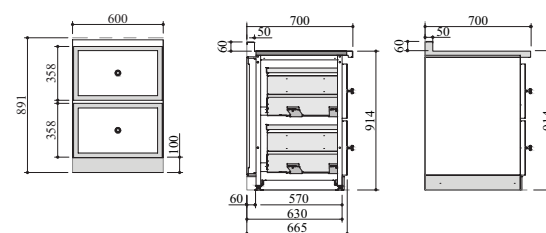

MAXI TIROIR 800: T18

800 W x 665 D x 891 H (mm)
 31.5 W x 26.2 D x 35.0 H (inches)
 4 Small Drawers
 Rubber liner bottoms in each drawer
 Starting from \$16,400

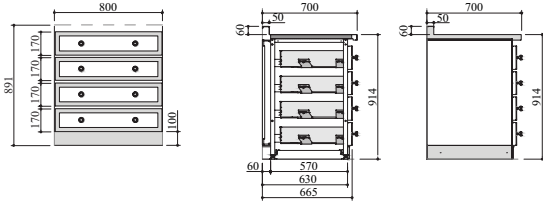

MAXI RANGEMENT 800: TP8

800 W x 665 D x 891 H (mm)
 31.5 W x 26.2 D x 35.0 H (inches)
 2 Small Drawers
 1 Large Drawer
 Rubber liner bottoms in each drawer
 Starting from \$13,400

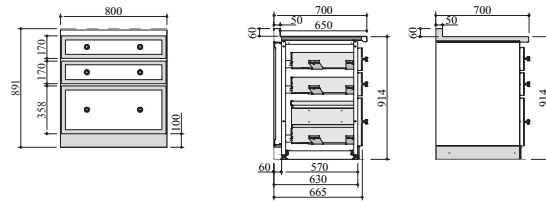

MEUBLE POUBELLE (WASTE BIN) 800 - BOTTOM: TB8

800 W x 665 D x 891 H (mm)
 31.5 W x 26.2 D x 35.0 H (inches)
 1 Small Top Drawer
 1 Large Bottom Waste Bin
 Top drawer can be a "false drawer" to accommodate a sink
 One 39 L Waste Bin and Two 28L Waste Bins sold separately — \$2,000 (see page 35)
 Starting from \$13,4600

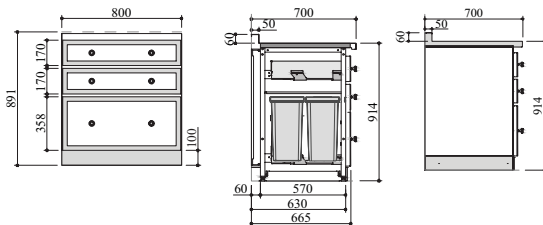

MAXI CASSEROLIERIE 800: TG8

800 W x 665 D x 891 H (mm)
 31.5 W x 26.2 D x 35.0 H (inches)
 2 Large Drawers
 Rubber liner bottoms in each drawer
 Starting from \$12,700

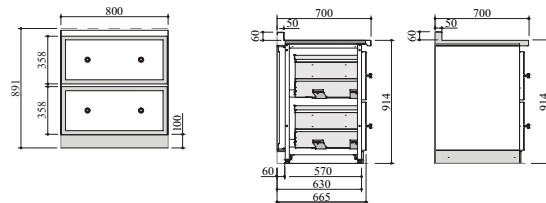

FRUITIER: PEF

500 W x 630 D x 891 H (mm)
 19.7 W x 24.8 D x 35.0 H (inches)
 3 Shelves with Dark Walnut or Light Oak Baskets included
 Walnut starting from \$14,100
 Oak starting from \$13,400

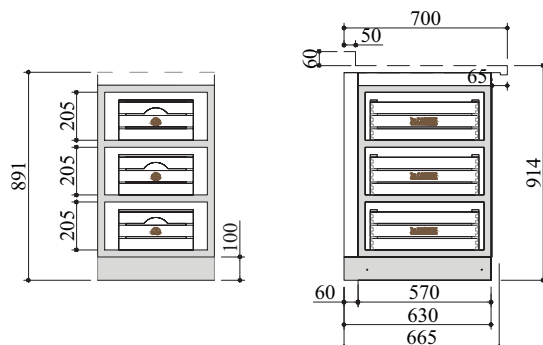

BUTCHER BLOCK: TAG

700 W x 615 D x 830 H (mm)
 27.6 W x 24.2 D x 32.7 H (inches)
 Solid Oak Butcher Block with Beech Top Board
 1 Drawer
 Knife Rack
 Available Trims: A, D, B, L, C, N, V and K (see page 14)
 Walnut Stain starting from \$12,900
 Standard Oak starting from \$11,700

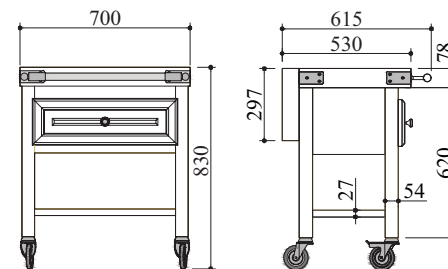

PORTE TECHNIQUE (LOWERED) 450: P4R

450 W x 665 D x 720 H (mm)
 17.7 W x 26.2 D x 28.3 H (inches)
 1 Large Door, Left- or Right-hand Hinged
 1 False Drawer
 Drawer may be made functional for additional cost
 Supplied without a shelf or base
 Open bottom with 2 Stainless Steel inner sides and back
 Shelf may be added: ETS Middle Shelf \$600 or ETB Bottom Shelf \$600
 Starting from \$11,100

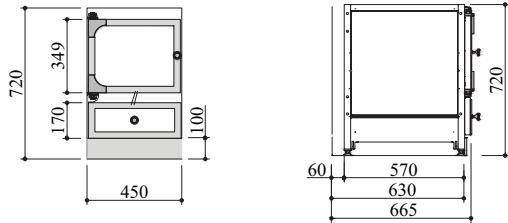

PORTE TECHNIQUE (LOWERED) 900 : P9R

900 W x 665 D x 720 H (mm)
 35.5 W x 26.2 D x 28.3 H (inches)
 2 Doors with Center Divider and False Drawers
 Shelf may be added: ETS Middle Shelf \$1,000 or ETB Bottom Shelf \$1,300
 Stainless Steel inner sides and back
 Starting from \$12,600

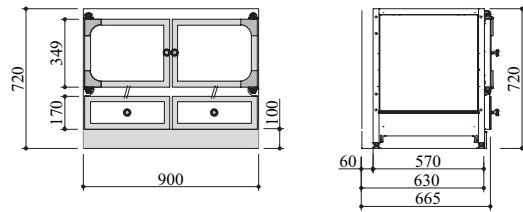

SPECIAL COOKTOP ONLY WITH STAINLESS STEEL TOP 450: DN4

450 W x 700 D x 260 H (mm)
 17.7 W x 27.6 D x 10.2 H (inches)
 Cooktop Only Cabinetry with Stainless Steel Top
 Often used adjacent to Château rangetops
 Starting from \$5,400

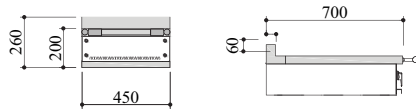

SPECIAL COOKTOP ONLY WITH STAINLESS STEEL TOP 600: DN6

600 W x 700 D x 260 H (mm)
 23.6 W x 27.6 D x 10.2 H (inches)
 Cooktop Only Cabinetry with Stainless Steel Top
 Often used adjacent to Château rangetops
 Starting from \$5,900

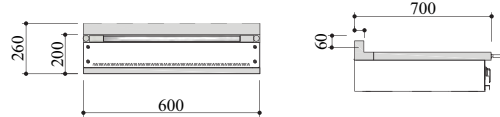

OPTIONAL FINISHED SIDES AND EXTERIOR BACK: EME

- 0 - Enameled side without frame: Standard Color from: \$1,200
- A - 1 false frame on the side or the back: Standard Color and Trim from: \$3,700
- B - 2 false frames on the side or the back: Standard Color and Trim from: \$4,400
- C - 2 false frames on the side or the back: Standard Color and Trim from: \$4,400

0 - Enameled side without frame

A - 1 false frame on the side or the back

B - 2 false frames on the side or the back

C - 2 false frames on the side or the back

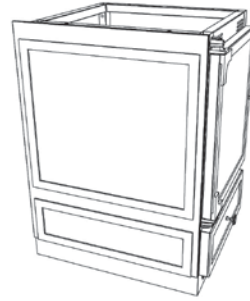
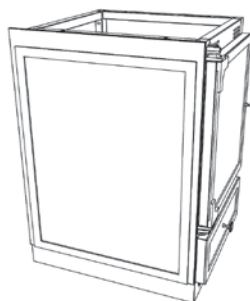
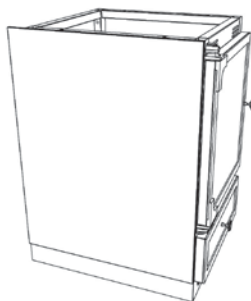

PLEASE NOTE: Panels with trim are 19 mm wide (0.75 inches) and panels without trim are 15 mm wide (0.60 inches)

Corner & Filler Cabinetry

CORNER CABINET: LM1, LM2

1220-1320 W x 670-770 D x 891 H (mm)
 48-52 W x 26.4-30.3 D x 10.2 H (inches)

Corner cabinetry, designed specifically to allow for storage in lost corners. Fixed Shelving, without stainless steel sides, or Rotating Shelving, with stainless steel sides, can be accessible on the right or left.

LM1: Corner Cabinet (center filler <100mm) - Starting from \$21,200
 LM2: Corner Cabinet (center filler between 101mm and 200mm) - Starting from \$22,900

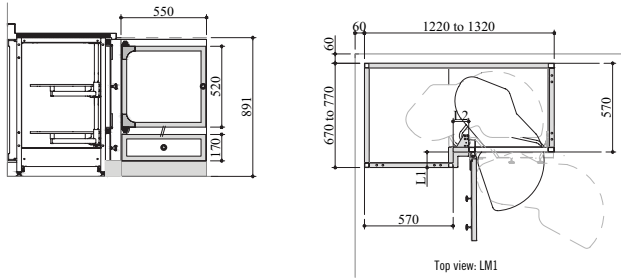

CORNER SHELVES PLUS FILLER: ANE

730 W x 700 D x 891 H (mm)
 28.7 W x 27.6 D x 35.0 H (inches)

The cabinet is equipped with two shelves that are attached to a rotating arm. This system is ideal for ease and convenience with plenty of storage. (< 200 mm) with filler Starting from \$6,400

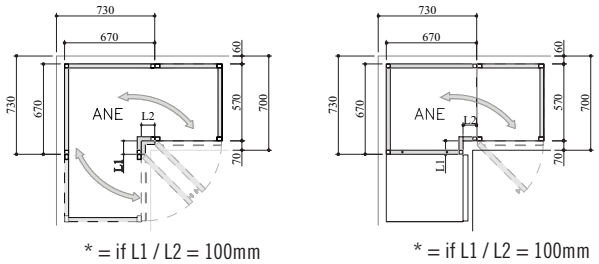

STRAIGHT FILLER: FID

(<200mm) - Starting from \$700

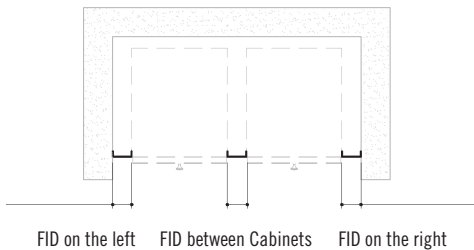

CORNER FILLER: FIA

(<200mm) - Starting from \$1,100

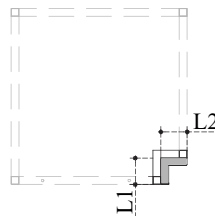

Accessories

WASTE BIN 500: BIN & TIN \$1,000

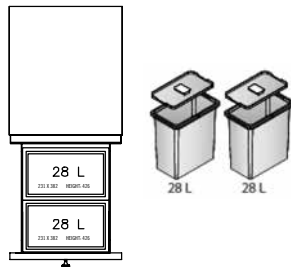

WASTE BIN 600: BIM & TMB \$1,500

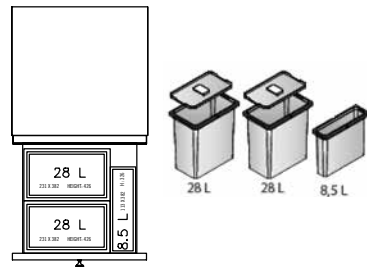

WASTE BIN 800: B18 & TB8 \$2,000

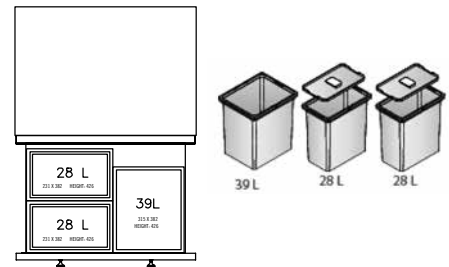

Ordering & Shipping

All Château products (Château Ranges, Cooktops, Hoods, Rôtisserie, Cabinetry and Accessories) are custom-ordered and quoted on a per-job basis. In our current environment, lead times are constantly changing, please consult your sales person for current lead time. Freight rates are not reflected in retail prices and will be quoted on a per-job basis. Standard freight is air freighted from France to U.S. and then truck to local delivery.

All CornuFé products (CornuFé 110 and 90) are inventoried at Middleby Residential and shipped upon order or around target delivery date. If a product is not in stock, lead time will be quoted. Standard delivery time is 1-3 weeks for products in stock. Freight rates are not reflected in retail prices and will be quoted at time of sale.

CHÂTEAU SERIES SHIPPING & DELIVERY

All Château units must ship via inside delivery due to weight and value. Quoted freight includes wooden crate and import costs (customs, duties and taxes).

Inside Delivery Includes:

- Insurance
- Delivery crew of 2-4 men
- Delivery up to 2 flights of stairs (includes outside and inside stairs)
- * Passageway must be accessible and wide enough for delivery crew to maneuver
- 90 minute onsite delivery time
- Placement of unit inside customer's home, three feet away from its location
- Debris removal of original crate packaging, including the wooden crate, pallet, Styrofoam, and plastic
- Delivery Monday to Friday from 8am -5pm
- Delivery within designated 5-hour delivery window, during normal business hours

CORNUFÉ SERIES SHIPPING & DELIVERY

CornuFé units may be shipped curbside/warehouse delivery or in-home delivery. Note that rates for each option are quoted by state and unit.

Curbside delivery service includes:

- Insurance
- Delivery crew of 1-2 men
- Delivery up to the driveway
- Delivery Monday to Friday from 8am -5pm
- Delivery within designated 5-hour delivery window, during normal business hours

In-home delivery is identical to Château in-home as detailed above

Items *not* covered (note the below conditions will incur additional costs):

- Delivery time of over 90 minutes
- Additional labor (more than 2 men for curbside delivery and more than 3 men for inside delivery)
- Waiting time (if recipient not home or not ready to receive order upon arrival)
- Customer pick-up
- Consignee no show
- Consignee refusal of delivery
- Consignee refusal within 24 hours of scheduled delivery
- Required use of elevator for delivery
- Unusual transportation costs – ferries, cranes, etc.
- Weekend or holiday delivery
- After hours delivery
- Specific time delivery
- Storage of unit at local distribution center

Conditions *never* covered under freight charge:

- Gas or electrical hookup
- Removal of any non-La Cornue debris
- Light assembly

Please note: It is the responsibility of the purchaser to arrange installation. La Cornue is not responsible for installation.

NATIONWIDE SERVICE & PARTS INFORMATION

For service, contact the La Cornue Service Center at 877-LACORNU(e) or 877-522-6768.

LA CORNUÉ WARRANTY AND LIMITATIONS

La Cornue warrants the original user that the product(s) manufactured are free from defects on material and workmanship for a period of five years from date of installation, not to exceed 66 months from date of shipment by Company. For extended warranty options due to delay in installation, please contact us at lacornue@middlebyresidential.com.

CODE COMPLIANCE INFORMATION

Château Stoves, Cooktops and Rôtisserie are UL Approved for residential use *unless otherwise noted*.

CornuFé Stoves carry CSA Approval for residential installation

Please note: According to ANSI Standard Z223, noncombustible ventilation equipment must be used in conjunction with La Cornue equipment.

LACORNUE

PURVEYORS OF HANDCRAFTED FRENCH RANGES SINCE 1908

A MEMBER OF THE MIDDLEBY RESIDENTIAL LUXURY BRAND PORTFOLIO

LA CORNUE IS DISTRIBUTED IN USA, MEXICO AND WILLIAMS-SONOMA CANADA
BY MIDDLEBY RESIDENTIAL. FOR MORE INFORMATION, OR TO FIND A DEALER NEAR YOU, PLEASE
CONNECT WITH US: [FACEBOOK.COM/LACORNUE](https://www.facebook.com/lacornue) | [INSTAGRAM.COM/LACORNUEUSA](https://www.instagram.com/lacornueusa) | [TWITTER.COM/LACORNUE](https://www.twitter.com/lacornue)

lacornueusa.com

