

GRAND PALAIS 180: G48

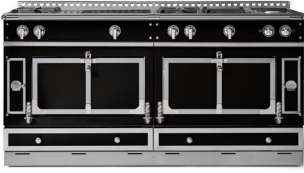

The Grand Palais 180 is the crown jewel of the Château Series, commanding respect and admiration in any kitchen. Almost 6 feet in length, the range boasts one grand vaulted gas oven and one grand vaulted electric oven, set beneath one of seven rangetop configurations.

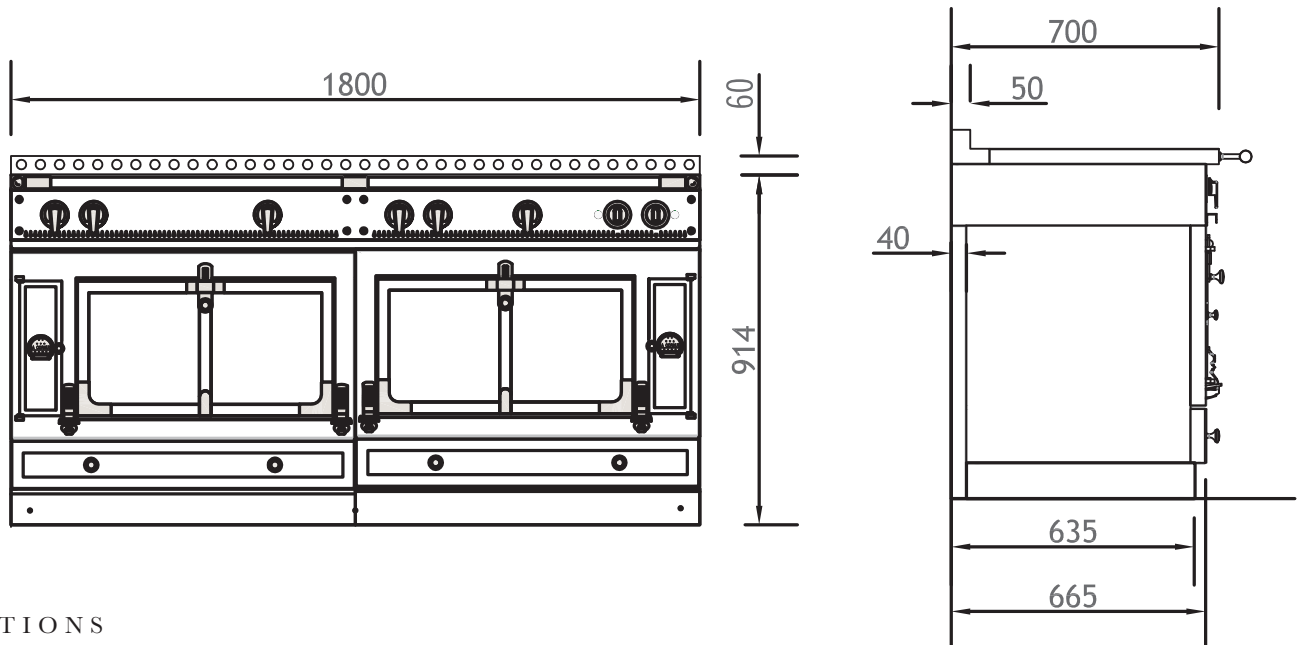

SPECIFICATIONS

GRAND PALAIS 180: G48

1800 W x 700 D x 914 H (mm)
70.9 W x 27.6 D x 36 H (inches)
Approx. 710 lb. uncrated, 1320 lb. crated
Choice of 7 top configurations
Starting from \$60,300

STANDARD FEATURES INCLUDE:

1 Grand Vaulted Gas Oven with Electric Broiler 22.6W x 19.8D x 11.8H – 3.1 cubic feet (left)
1 Grand Vaulted Electric Oven with Electric Broiler 22.6W x 17.5D x 11.8H – 2.7 cubic feet (right)

GRAND PALAIS RANGETOP 180: T48

1800 W x 700 D x 200 H (mm)
70.9 W x 27.6 D x 7.9 H (inches)
Approx. 290 lb. uncrated, 450 lb. crated
Choice of 7 top configurations
Starting from \$25,600

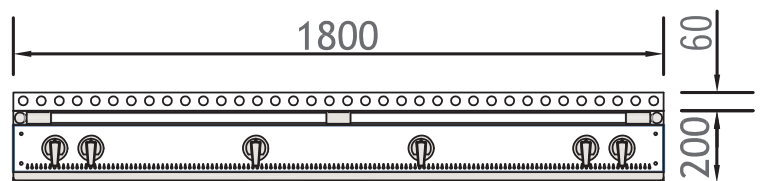

LE CHÂTEAU OPTIONS

Enamel and Metal Body Options: Château ranges are available in a variety of 50 enamel or metal body finishes, and can also be customized in a one-of-a-kind color. Prices may vary depending on colors selected.

Trim Options: Polished Brass, Brushed Brass, Brushed Stainless Steel, Brushed Nickel, Polished Chrome, Polished Copper, Matte Black, Black Shiny Chrome, Matte Bronze, Brushed Copper and Polished Stainless Steel. Prices may vary depending on trims selected.



GRAND PALAIS 180: G48

RANGETOP CONFIGURATIONS



180 US N1
 2 gas burners (small burner at the back)
 1 Plaque "French Top" (large)
 1 maxi burner
 2 gas burners (small burner at the back)



180 US N2*
 2 gas burners (small burner at the back)
 1 Plaque "French Top" (large)
 1 large electric Teppan-Yaki
 2 induction plates

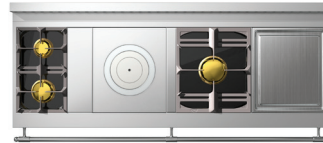

180 US N3
 2 gas burners (small burner at the back)
 1 Plaque "French Top" (large)
 1 maxi burner
 1 large electric Teppan-Yaki

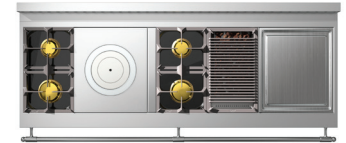

180 US N5
 2 gas burners (small burner at the back)
 1 Plaque "French Top" (large)
 2 gas burners (small burner at the back)
 1 gas lava-rock grill
 1 large electric Teppan-Yaki



180 US N8*
 2 gas burners (small burner at the back)
 1 Plaque "French Top" (large)
 2 gas burners (small burner at the back)
 1 large electric Teppan-Yaki
 2 induction plates



180 US N9
 2 gas burners (small burner at the back)
 1 Plaque "French Top" (large)
 2 gas burners (small burner at the back)
 1 large electric Teppan-Yaki



180 US NM*
 2 gas burners (small burner at the back)
 1 Plaque "French Top" (large)
 1 maxi burner
 2 induction plates

*Induction element incurs an upcharge of \$2,275 per element

CHÂTEAU SERIES HOODS

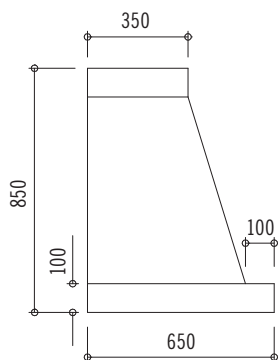

Standard Configuration Wall Hood
 Side View

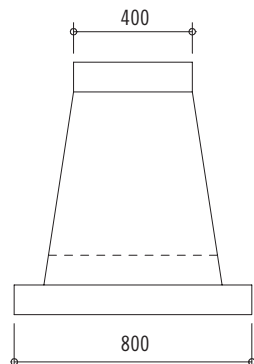

Standard Configuration Island Hood
 Side View

Since every installation is unique, Hotte Chateau hoods are sold without a blower system, as a shell-only. Motorized hoods are available for standard wall-mounted Hotte Chateau. Please contact your local HVAC contractor to discuss specific installation requirements. La Cornue does offer standard Chateau hood models with blower option, as noted below. For custom inserts, please inquire with Middleby Residential directly.

Traditional wall mounted hood. Island Hoods are also available. Custom Hoods available by quote. Hood height may be increased up to 1500 mm/ 59 inches by adding height to the upper band (total maximum height would be 2250 mm/88.5 inches).

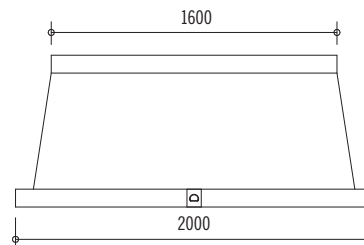

HOTTE GRAND PALAIS 180: H20T0
 2000 W x 850 H x 650 D (mm)
 78.7 W x 33.5 H x 25.6 D (inches)
Shell-Only Starting from \$13,100
Mortorized Hood Starting from \$16,300
Island configuration: H20C0
Starting from \$22,400
Motorized Island Hood Starting from: \$27,100

*Motorized Factory installed blower and liner are available for the Chateau Hotte wall mounted hoods only. Motorized hoods include a 1200 CFM blower for all two oven cookers and a 600 CFM blower for all one oven cookers. They also include, liner, lights, mesh magnetic filters and a remote control.