

CHÂTEAU SUPRÊME GRAND PALAIS 180 AND 150

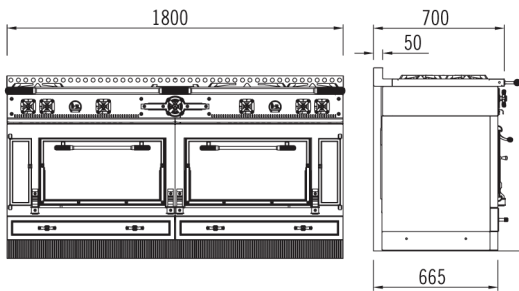

The Château range is an icon of the French art of living throughout the world. Reimagined by Ferris Rafauli, this contemporary version is the ultimate in sophistication. To create it, the designer considered and revised each element of the range to bring out its most distinctive characteristics, taking the precision of the lines and details to a whole new level.

CHÂTEAU SUPRÊME GRAND PALAIS 180



CHÂTEAU SUPRÊME 150

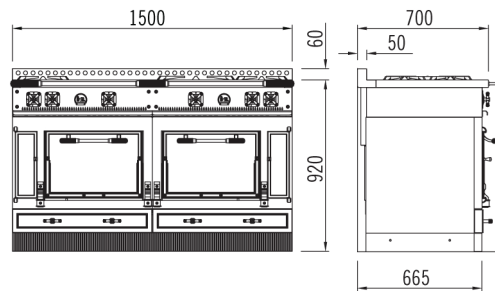

OPTIONAL WARMING DRAWER

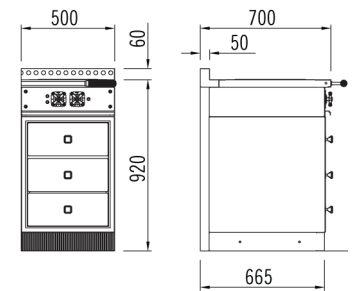

SPECIFICATIONS

CHÂTEAU SUPRÊME GRAND PALAIS 180

1800 W x 700 D x 914 H (mm)
70.9 W x 27.6 D x 36 H (inches)
Approx. 710 lb. uncrated, 1320 lb. crated

OPTIONS:

- Two optional warming cupboard modules
- Six cooktop configurations (see reverse side for options)
- Château Suprême 180 hood, finished to match the range, or in an optional leather-covered exterior

Starting from \$117,000

OVENS:

- 1 Grand Vaulted Gas Oven with Electric Broiler 22.6W x 19.8D x 11.8H – 3.1 cubic feet (left)
 - 1 Grand Vaulted Electric Oven with Electric Broiler 22.6W x 17.5D x 11.8H – 2.7 cubic feet (right)
- Includes:* interior lighting, cleanemail coating, one electric grill and an oven kit
(one large grill, one drip pan, one porcelain roasting dish, one raised grill)

CHÂTEAU SUPRÊME 150

1500 W x 700 D x 914 H (mm)
59.1 W x 27.6 D x 36 H (inches)
Approx. 620 lb. uncrated, 1230 lb. crated

OPTIONS:

- Two optional warming cupboard modules
- Three cooktop configurations (see reverse side for options)
- Château Suprême 150 hood, finished to match the range, or in an optional leather-covered exterior

Starting from \$113,000

OVENS:

- 1 Vaulted Gas Oven with Electric Broiler 16.8W x 19.8D x 11.8H – 2.3 cubic feet (left)
 - 1 Vaulted Electric Oven with Electric Broiler 16.8W x 17.5D x 11.8H – 2.0 cubic feet (right)
- Includes:* interior lighting, cleanemail coating, one electric grill and an oven kit
(one large grill, one drip pan, one porcelain roasting dish, one raised grill)

DETAILS EXCLUSIVE TO ALL CHÂTEAU SUPRÊME RANGES:

- Iconic La Cornue – Ferris Rafauli brand plate
- Four new Château Suprême Colors developed by Ferris Rafauli exclusively for this range, including FR Blue, Essex Green, California Blue and Cloud Gray, as well as being available in most existing Château finishes
- Burners and French Top engraved with the La Cornue stars
- Solid walnut chopping block included with all cooktop configurations featuring the Lava Rock Grill
- Designer dual-finish control knobs
- Art Deco inspired bezels and toe kick featuring individually aligned moulded bars

CHÂTEAU SUPRÊME GRAND PALAIS 180 AND 150

180 RANGETOP CONFIGURATIONS

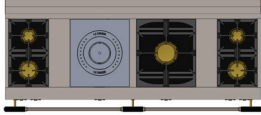

- 180 N1**
2 gas burners
1 Plaque "French Top" (large)
1 Power burner
2 gas burners

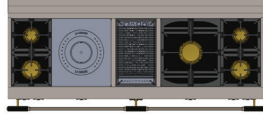

- 180 N1 SPE**
2 Gas burners
1 Plaque "French Top" (large)
1 Gas lava-rock grill
1 Power burner
2 Gas burners
Walnut chopping block

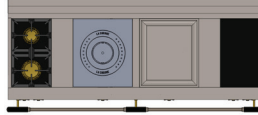

- 180 N2**
2 gas burners
1 Plaque "French Top" (large)
1 Large teppanyaki
2 induction hob

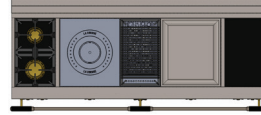

- 180 N2 SPE**
2 Gas burners
1 Plaque "French Top" (large)
1 Gas lava-rock grill
1 Large teppanyaki
2 Induction hob
Walnut chopping block

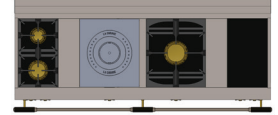

- 180 NM**
2 gas burners
1 Plaque "French Top" (large)
1 Power burner
2 induction hob

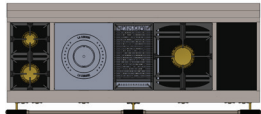

- 180 NM SPE**
2 gas burners
1 Plaque "French Top" (large)
1 Gas lava-rock grill
1 Power burner
2 induction hob
Walnut chopping block

150 RANGETOP CONFIGURATIONS

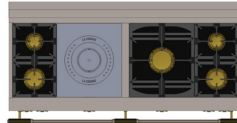

- 150 K1**
2 Gas burners
1 Plaque "French Top" (large)
1 Power burner
2 Gas burners

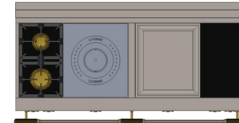

- 150 K2**
2 Gas burners
1 Plaque "French Top" (large)
1 Large teppanyaki
2 induction hob

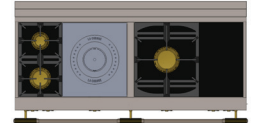

- 150 KM**
2 Gas burners
1 Plaque "French Top" (large)
1 power burner
2 induction hob

CHÂTEAU SUPRÊME HOOD 180

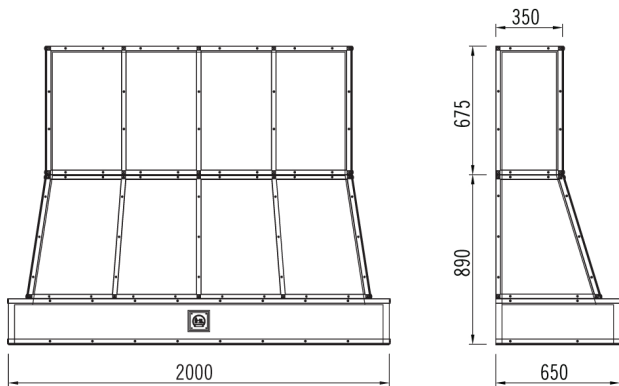

CHÂTEAU SUPRÊME HOOD 150

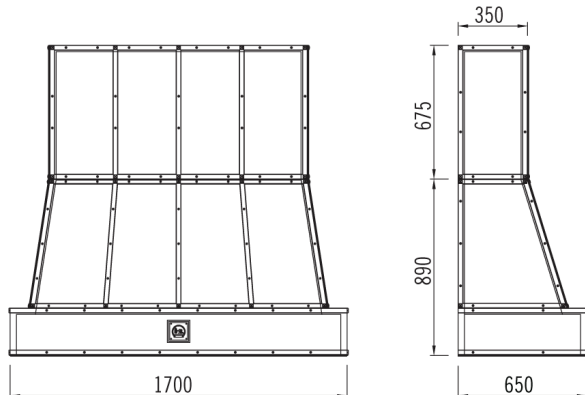

CHÂTEAU SUPRÊME SERIES HOODS

With remarkable performance, the Château Suprême Hood by Ferris Rafauli has been designed to allow you to cook with convenience while keeping the unique Art Deco signature of the range. Available in four new exclusive Château Suprême Colors, as well as in all existing Château paint colors and metal finishes. Exclusive to The Château Suprême Hood is the option to finish the exterior in genuine leather. The Château Suprême Hood by Ferris Rafauli is available in both the 180 & 150 sizing, and adds a unique designer presence to any kitchen.

CHÂTEAU SUPRÊME HOOD 180

2000 W x 650 D x 1565 H (mm)
78.7 W x 25.6 D x 61.6 H (inches)
Weight: 728 lbs
6 Baffle Filters
6 LED Lights
1200 CFM Internal Blower
Starting from \$27,000

CHÂTEAU SUPRÊME HOOD 150

1700 W x 650 D x 1565 H (mm)
66.9 W x 25.6 D x 61.6 H (inches)
Weight: 684 lbs
3 Baffle Filters
5 LED Lights
1200 CFM Internal Blower
Starting from \$24,000