

135: G43

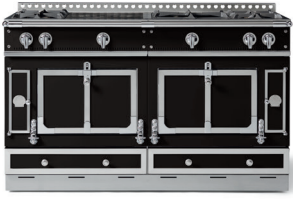

The Châtelet 135 is the perfect balance of symmetry, design and function. With a large vaulted oven (gas or electric) and a warming oven, the nearly 53" unit offers eight rangetop configurations to meet any culinary need.

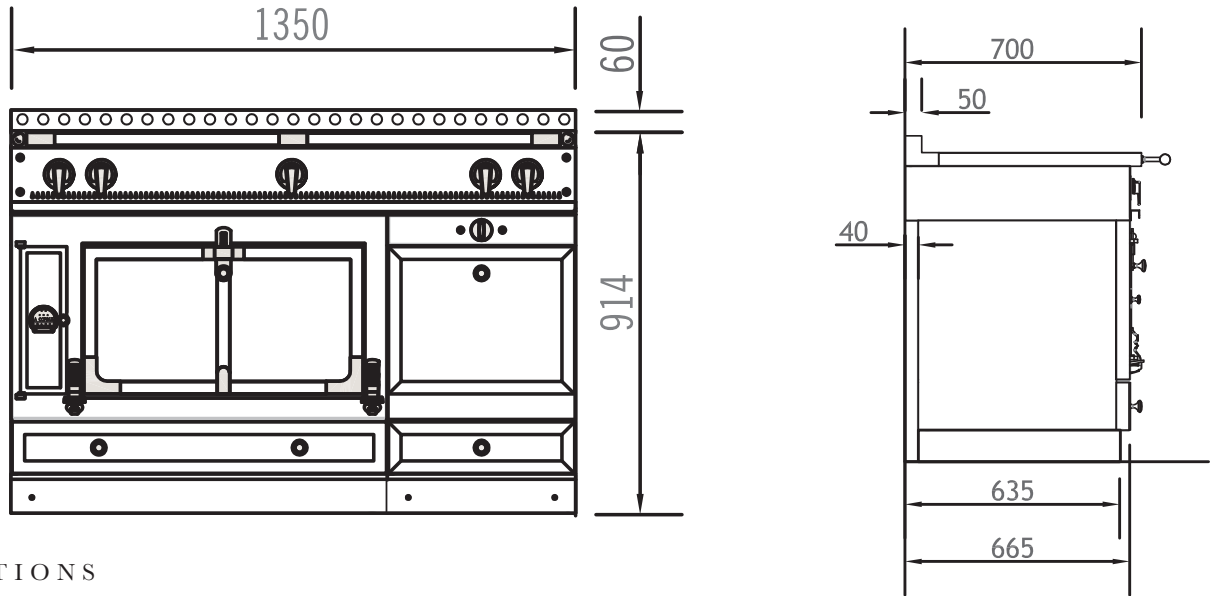

SPECIFICATIONS

CHÂTELET 135 WD: G43

1350 W x 700 D x 920 H (mm)
 53.15 W x 27.6 D x 36 H (inches)
 Approx. 500 lb. uncrated, 800 lb. crated
 Choice of 7 top configurations
Starting from \$ 47,900

STANDARD FEATURES INCLUDE:

1 Grand Vaulted Gas Oven with Electric Broiler 22.6W x 19.8D x 11.8H – 3.1 cubic feet (left) **OR**
 1 Grand Vaulted Electric Oven with Electric Broiler 22.6W x 19.8D x 11.8H – 2.7 cubic feet (right)
AND
 1 Electric Warming Drawer with temperature ranging from 130 – 240 F

CHÂTELET RANGETOP 135: G43

1350 W x 700 D x 200 H (mm)
 53.15 W x 27.6 D x 7.9 H (inches)
 Approx. 220 lb. uncrated, 320 lb. crated
 Choice of 7 top configurations
Starting from \$16,800

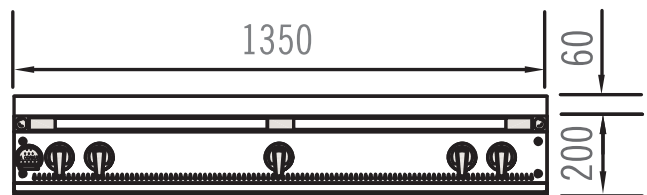

LE CHÂTEAU OPTIONS

Enamel and Metal Body Options: Château ranges are available in a variety of 50 enamel or metal body finishes, and can also be customized in a one-of-a-kind color. Prices may vary depending on colors selected.

Trim Options: Polished Brass, Brushed Brass, Brushed Stainless Steel, Brushed Nickel, Polished Chrome, Polished Copper, Matte Black, Black Shiny Chrome, Matte Bronze, Brushed Copper and Polished Stainless Steel. Prices may vary depending on trims selected.



135: G43

RANGETOP CONFIGURATIONS



135 US H0
 2 gas burners (small burner at the back)
 1 Plaque "French Top" (large)
 2 gas burners (small burner at the back)



135 US H1
 2 gas burners (small burner at the back)
 1 maxi burner
 2 gas burners (small burner at the back)



135 US H2
 2 gas burners (small burner at the back)
 1 Plaque "French Top" (large)
 1 large electric Teppan-Yaki

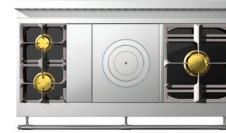

135 US H3
 2 gas burners (small burner at the back)
 1 Plaque "French Top" (large)
 1 maxi burner



135 US HC*
 2 gas burners (small burner at the back)
 1 Plaque "French Top" (large)
 2 gas burners (small burner at the back)
 2 induction plates



135 US H6
 2 gas burners (small burner at the back)
 1 Plaque "French Top" (large)
 2 gas burners (small burner at the back)
 1 gas lava-rock grill



135 US HF
 2 gas burners (small burner at the back)
 1 maxi burner
 1 large electric Teppan-Yaki

*Induction element incurs an upcharge of \$2,200 per element

CHÂTEAU SERIES HOODS

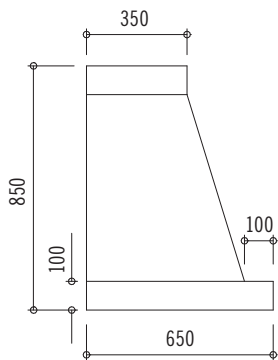

Standard Configuration Wall Hood
 Side View

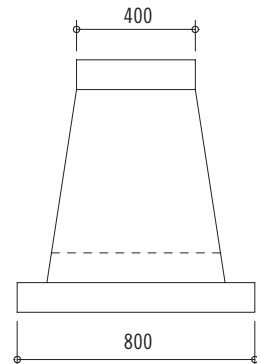

Standard Configuration Island Hood
 Side View

Since every installation is unique, Hotte Chateau hoods are sold without a blower system, as a shell-only. Motorized hoods are available for standard wall-mounted Hotte Chateau. Please contact your local HVAC contractor to discuss specific installation requirements. La Cornue does offer standard Chateau hood models with blower option, as noted below. For custom inserts, please inquire with Middleby Residential directly.

Traditional wall mounted hood. Island Hoods are also available. Custom Hoods available by quote. Hood height may be increased up to 1500 mm/ 59 inches by adding height to the upper band (total maximum height would be 2250 mm/88.5 inches).

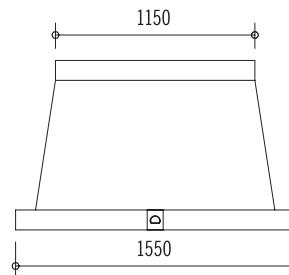

HOTTE CHATEAU 135: H15TO
 1550 W x 850 H x 650 D (mm)
 61.0 W x 33.5 H x 25.6 D (inches)
 Shell-Only Starting from \$10,400
 Motorized Hood Starting from \$13,400
Island configuration: H15CO
 Starting from \$17,800

*Motorized Factory installed blower and liner are available for the Chateau Hotte wall mounted hoods only. Motorized hoods include a 1200 CFM blower for all two oven cookers and a 600 CFM blower for all one oven cookers. They also include, liner, lights, mesh magnetic filters and a remote control.